

# AeroNOx 2.0™

## Portable Nitric Oxide Titration & Monitoring System Service Manual

# **AeroNOx 2.0™**

## **Portable Nitric Oxide Titration & Monitoring System Service Manual**

- **Phone:** (512) 873-0033
- **Fax:** (512) 873-9090
- **E-Mail:** [sales@int-bio.com](mailto:sales@int-bio.com)
- **Website:** <http://www.int-bio.com>

- **Mailing address:**

**International Biomedical  
8206 Cross Park Dr.  
Austin, TX 78754  
USA**

- **Authorized representative in Europe for Regulatory Affairs:**

**Emergo Europe  
Prinsessegracht 20  
2514 AP  
The Hague, The Netherlands**

**CE**  
2797



# TABLE OF CONTENTS

1.	INTRODUCTION .....	10
1.1.	Important Safety Considerations.....	10
2.	SPECIFICATIONS .....	15
2.1.	Symbols Table .....	15
2.2.	Abbreviations .....	17
2.3.	Ventilator Compatibility.....	18
2.4.	Measurement Range and Accuracy .....	18
2.5.	Backup Delivery Regulator .....	18
2.6.	INostat Bagger.....	18
2.7.	AeroNOx 2.0™ Delivery Regulator .....	19
2.8.	AeroNOx 2.0™ Physical Specifications.....	19
2.9.	AeroNOx 2.0™ Environmental Specifications .....	19
2.10.	AeroNOx 2.0™ Electrical Specifications .....	20
2.11.	Sensor Specifications .....	20
2.12.	EMC Compliance.....	20
2.13.	Physical Dimensions and Center of Mass .....	23
2.14.	VESA Mounting Pattern.....	23
3.	THEORY OF OPERATION .....	24
3.1.	Front Panel .....	24
3.2.	Front View - Labeled.....	24
3.3.	Button Functions .....	25
3.4.	Rear Panel .....	26
3.5.	Rear View - Labeled.....	26
3.6.	Connection to Ventilator Circuit.....	26
3.7.	Delivery System .....	28
3.8.	Sample Analysis System.....	29
3.9.	General Features and Operation .....	30
3.10.	Environmental Effects .....	34
3.11.	Mass Flow Meter Circuit.....	40
4.	CALIBRATION.....	41
4.1.	Low Range Calibration (Daily) .....	41
4.2.	O <sub>2</sub> High Range Calibration (Weekly) .....	42
4.3.	NO High Range Calibration (Weekly) .....	44
4.4.	NO <sub>2</sub> High Range Calibration (Weekly).....	46
5.	MAINTENANCE .....	49
5.1.	AeroNOx 2.0™ Service Procedures Overview .....	49
5.2.	Maintenance Tools.....	50
5.3.	Scheduled Maintenance .....	50
5.4.	Cleaning the AeroNOx 2.0™ .....	51
5.5.	Preventive Maintenance .....	51
5.6.	Replacing NO, NO <sub>2</sub> and O <sub>2</sub> Sensors .....	52

# TABLE OF CONTENTS

---

5.7.	SLA Battery Replacement .....	55
5.8.	LiFePO <sub>4</sub> Battery Replacement .....	55
5.9.	AeroNOx 2.0™ MFM Flow Check/Leak Test Procedure .....	57
5.10.	AeroNOx 2.0™ Sample Rate Adjustment Procedure .....	61
5.11.	AeroNOx 2.0™ Gas Testing Procedure .....	66
5.12.	Repair Maintenance .....	74
6.	TROUBLESHOOTING .....	81
6.1.	Troubleshooting Alarms Guide .....	81
6.2.	Troubleshooting Other Symptoms and Solutions .....	86
6.3.	Customer Service .....	89
7.	APPENDIX .....	90
7.1.	External Power Supply Electrical Specifications .....	90
7.2.	Isolation Diagram .....	91
7.3.	Nitric Oxide Sensor Specifications .....	92
7.4.	NO <sub>2</sub> Sensor Specifications .....	94
7.5.	Oxygen Sensor Specifications .....	96
7.6.	Mass Flow Sensor Specifications .....	97
7.7.	Recommended Practices for Handling of Gas Cylinders and Regulators to Maintain Gas Quality .....	98
7.8.	System Wiring Diagram .....	101
7.9.	Sensor Connection Block Diagram .....	102

# LANGUAGE DISCLAIMER

---



## WARNING:

This service manual is available in English only.

- (EN)
- If a customer's service provider requires a language other than English, it is the customer's responsibility to provide translation services.
  - Do not attempt to service the equipment unless this service manual has been consulted and is understood.
  - Failure to heed this warning may result in injury to the service provider, operator, or patient from electric shock, mechanical hazards, or other hazards.
- 



## VÝSTRAHA

Tento provozní návod existuje pouze v anglickém jazyce.

- (CS)
- V případě, že externí služba zákazníkům potřebuje návod v jiném jazyce, je zajištění překladu do odpovídajícího jazyka úkolem zákazníka.
  - Nesnažte se o údržbu tohoto zařízení, aniž byste si přečetli tento provozní návod a pochopili jeho obsah.
  - V případě nedodržování této výstrahy může dojít k poranění pracovníka prodejního servisu, obslužného personálu nebo pacientů vlivem elektrického proudu, respektive vlivem mechanických či jiných rizik.
- 



## ADVARSEL

Denne servicemanual findes kun på engelsk.

- (DA)
- Hvis en kundes tekniker har brug for et andet sprog end engelsk, er det kundens ansvar at sørge for oversættelse.
  - Forsøg ikke at servicere udstyret uden at læse og forstå denne servicemanual.
  - Manglende overholdelse af denne advarsel kan medføre skade på grund af elektrisk stød, mekanisk eller anden fare for teknikeren, operatøren eller patienten.
- 



## WAARSCHUWING

Deze onderhoudshandleiding is enkel in het Engels verkrijgbaar.

- (NL)
- Als het onderhoudspersoneel een andere taal vereist, dan is de klant verantwoordelijk voor de vertaling ervan.
  - Probeer de apparatuur niet te onderhouden alvorens deze onderhoudshandleiding werd geraadpleegd en begrepen is.
  - Indien deze waarschuwing niet wordt opgevolgd, zou het onderhoudspersoneel, de operator of een patiënt gewond kunnen raken als gevolg van een elektrische schok, mechanische of andere gevaren.
-

# LANGUAGE DISCLAIMER

---



## ПРЕДУПРЕЖДЕНИЕ

Това упътване за работа е налично само на английски език.

- (BG)
- Ако доставчикът на услугата на клиента изиска друг език, задължение на клиента е да осигури превод.
  - Не използвайте оборудването, преди да сте се консултирали и разбрали упътването за работа.
  - Неспазването на това предупреждение може да доведе до нараняване на доставчика на услугата, оператора или пациента в резултат на токов удар, механична или друга опасност.
- 



## 警告

本维修手册仅提供英文版本。

- (ZH-CN)
- 如果客户的维修服务人员需要非英文版本，则客户需自行提供翻译服务。
  - 未详细阅读和完全理解本维修手册之前，不得进行维修。
  - 忽略本警告可能对维修服务人员、操作人员或患者造成电击、机械伤害或其他形式的伤害。
- 



## 警告

本服務手冊僅提供英文版本。

- (ZH-HK)
- 倘若客戶的服務供應商需要英文以外之服務手冊，客戶有責任提供翻譯服務。
  - 除非已參閱本服務手冊及明白其內容，否則切勿嘗試維修設備。
  - 不遵從本警告或會令服務供應商、網絡供應商或病人受到觸電、機械性或其他危險。
- 



## 警告

本維修手冊僅有英文版。

- (ZH-TW)
- 若客戶的維修廠商需要英文版以外的語言，應由客戶自行提供翻譯服務。
  - 請勿試圖維修本設備，除非您已查閱並瞭解本維修手冊。
  - 若未留意本警告，可能導致維修廠商、操作員或病患因觸電、機械或其他危險而受傷。
- 



## UPOZORENJE

Ovaj servisni priručnik dostupan je na engleskom jeziku.

- (HR)
- Ako davatelj usluge klijenta treba neki drugi jezik, klijent je dužan osigurati prijevod.
  - Ne pokušavajte servisirati opremu ako niste u potpunosti pročitali i razumjeli ovaj servisni priručnik.
  - Zanimarite li ovo upozorenje, može doći do ozljede davatelja usluge, operatera ili pacijenta uslijed strujnog udara, mehaničkih ili drugih rizika.
-

# LANGUAGE DISCLAIMER

---



## HOIATUS

See teenindusjuhend on saadaval ainult inglise keeles

- (ET)
- Kui klienditeeninduse osutaja nõuab juhendit inglise keelest erinevas keeles, vastutab klient tõlketeenuse osutamise eest.
  - Ärge üritage seadmeid teenindada enne eelnevalt käesoleva teenindusjuhendiga tutvumist ja sellest aru saamist.
  - Käesoleva hoiatuse eiramine võib põhjustada teenuseosutaja, operaatori või patsiendi vigastamist elektrilöögi, mehaanilise või muu ohu tagajärjel.
- 



## VAROITUS

Tämä huolto-ohje on saatavilla vain englanniksi.

- (FI)
- Jos asiakkaan huoltohenkilöstö vaatii muuta kuin englanninkielistä materiaalia, tarvittavan käännöksen hankkiminen on asiakkaan vastuulla.
  - Älä yritä korjata laitteistoa ennen kuin olet varmasti lukenut ja ymmärtänyt tämän huolto-ohjeen.
  - Mikäli tätä varoitusta ei noudateta, seurauksena voi olla huoltohenkilöstön, laitteiston käyttäjän tai potilaan vahingoittuminen sähköiskun, mekaanisen vian tai muun vaaratilanteen vuoksi.
- 



## ATTENTION

Ce manuel d'installation et de maintenance est disponible uniquement en anglais.

- (FR)
- Si le technicien d'un client a besoin de ce manuel dans une langue autre que l'anglais, il incombe au client de le faire traduire.
  - Ne pas tenter d'intervenir sur les équipements tant que ce manuel d'installation et de maintenance n'a pas été consulté et compris.
  - Le non-respect de cet avertissement peut entraîner chez le technicien, l'opérateur ou le patient des blessures dues à des dangers électriques, mécaniques ou autres.
- 



## WARNUNG

Diese Serviceanleitung existiert nur in englischer Sprache.

- (DE)
- Falls ein fremder Kundendienst eine andere Sprache benötigt, ist es Aufgabe des Kunden für eine entsprechende Übersetzung zu sorgen.
  - Versuchen Sie nicht diese Anlage zu warten, ohne diese Serviceanleitung gelesen und verstanden zu haben.
  - Wird diese Warnung nicht beachtet, so kann es zu Verletzungen des Kundendiensttechnikers, des Bedieners oder des Patienten durch Stromschläge, mechanische oder sonstige Gefahren kommen.
-



# LANGUAGE DISCLAIMER



## ΠΡΟΕΙΔΟΠΟΙΗΣΗ

Το παρόν εγχειρίδιο σέρβις διατίθεται μόνο στα αγγλικά.

(EL)

- Εάν ο τεχνικός σέρβις ενός πελάτη απαιτεί το παρόν εγχειρίδιο σε γλώσσα εκτός των αγγλικών, αποτελεί ευθύνη του πελάτη να παρέχει τις υπηρεσίες μετάφρασης.
- Μην επιχειρήσετε την εκτέλεση εργασιών σέρβις στον εξοπλισμό αν δεν έχετε συμβουλευτεί και κατανοήσει το παρόν εγχειρίδιο σέρβις.
- Αν δεν προσέξετε την προειδοποίηση αυτή, ενδέχεται να προκληθεί τραυματισμός στον τεχνικό σέρβις, στο χειριστή ή στον ασθενή από ηλεκτροπληξία, μηχανικούς ή άλλους κινδύνους.



## FIGYELMEZTETÉS

Ezen karbantartási kézikönyv kizárólag angol nyelven érhető el.

(HU)

- Ha a vevő szolgáltatója angoltól eltérő nyelvre tart igényt, akkor a vevő felelőssége a fordítás elkészítése.
- Ne próbálja elkezdni használni a berendezést, amíg a karbantartási kézikönyvben leírtakat nem értelmezték.
- Ezen figyelmeztetés figyelmen kívül hagyása a szolgáltató, működtető vagy a beteg áramütés, mechanikai vagy egyéb veszélyhelyzet miatti sérülését eredményezheti.



## AÐVÖRUN

Þessi þjónustuhandbók er aðeins fáanleg á ensku.

(IS)

- Ef að þjónustuveitandi viðskiptamanns þarfnast annas tungumáls en ensku, er það skylda viðskiptamanns að skaffa tungumálaþjónustu.
- Reynið ekki að afgreiða tækið nema að þessi þjónustuhandbók hefur verið skoðuð og skilin.
- Brot á sinna þessari aðvörun getur leitt til meiðsla á þjónustuvei:anda, stjórnanda eða sjúklings frá raflosti, vélrænu eða öðrum áhættum.



## AVVERTENZA

Il presente manuale di manutenzione è disponibile soltanto in lingua inglese.

(IT)

- Se un addetto alla manutenzione richiede il manuale in una lingua diversa, il cliente è tenuto a provvedere direttamente alla traduzione.
- Procedere alla manutenzione dell'apparecchiatura solo dopo aver consultato il presente manuale ed averne compreso il contenuto.
- Il mancato rispetto della presente avvertenza potrebbe causare lesioni all'addetto alla manutenzione, all'operatore o ai pazienti provocate da scosse elettriche, urti meccanici o altri rischi.



## 警告

このサービスマニュアルには英語版しかありません。

(JA)

- サービスを担当される業者が英語以外の言語を要求される場合、翻訳作業はその業者の責任で行うものとさせていただきます。
- このサービスマニュアルを熟読し理解せずに、装置のサービスを行わないでください。
- この警告に従わない場合、サービスを担当される方、操作員あるいは患者さんが、感電や機械的又はその他の危険により負傷する可能性があります。

# LANGUAGE DISCLAIMER

---



## 경고

본 서비스 매뉴얼은 영어로만 이용하실 수 있습니다.

- (KO)
- 고객의 서비스 제공자가 영어 이외의 언어를 요구할 경우, 번역 서비스를 제공하는 것은 고객의 책임입니다.
  - 본 서비스 매뉴얼을 참조하여 숙지하지 않은 이상 해당 장비를 수리하려고 시도하지 마십시오.
  - 본 경고 사항에 유의하지 않으면 전기 쇼크, 기계적 위험, 또는 기타 위험으로 인해 서비스 제공자, 사용자 또는 환자에게 부상을 입힐 수 있습니다.
- 



## BRĪDINĀJUMS

Šī apkopes rokasgrāmata ir pieejama tikai angļu valodā.

- (LV)
- Ja klienta apkopes sniedzējam nepieciešama informācija citā valodā, klienta pienākums ir nodrošināt tulkojumu.
  - Neveiciet aprīkojuma apkopi bez apkopes rokasgrāmatas izlasīšanas un saprašanas.
  - Šī brīdinājuma neievērošanas rezultātā var rasties elektriskās strāvas trieciens, mehānisku vai citu faktoru izraisītu traumu risks apkopes sniedzējam, operatoram vai pacientam.
- 



## ISPĒJIMAS

Šis ekspluatavimo vadovas yra tik anglų kalba.

- (LT)
- Jei kliento paslaugų tiekėjas reikalauja vadovo kita kalba – ne anglų, suteikti vertimo paslaugas privalo klientas.
  - Nemėginkite atlikti įrangos techninės priežiūros, jei neperskaitėte ar nesupratote šio ekspluatavimo vadovo.
  - Jei nepaisysite šio įspėjimo, galimi paslaugų tiekėjo, operatoriaus ar paciento sužalojimai dėl elektros šoko, mechaninių ar kitų pavojų.
- 



## ADVARSEL

Denne servicehåndboken finnes bare på engelsk.

- (NO)
- Hvis kundens serviceleverandør har bruk for et annet språk, er det kundens ansvar å sørge for oversettelse.
  - Ikke forsøk å reparere utstyret uten at denne servicehåndboken er lest og forstått.
  - Manglende hensyn til denne advarselen kan føre til at serviceleverandøren, operatøren eller pasienten skades på grunn av elektrisk støt, mekaniske eller andre farer.
- 



## OSTRZEŻENIE

Niniejszy podręcznik serwisowy dostępny jest jedynie w języku angielskim.

- (PL)
- Jeśli serwisant klienta wymaga języka innego niż angielski, zapewnienie usługi tłumaczenia jest obowiązkiem klienta.
  - Nie próbować serwisować urządzenia bez zapoznania się z niniejszym podręcznikiem serwisowym i zrozumienia go.
  - Niezastosowanie się do tego ostrzeżenia może doprowadzić do obrażeń serwisanta, operatora lub pacjenta w wyniku porażenia prądem elektrycznym, zagrożenia mechanicznego bądź innego.
-

# LANGUAGE DISCLAIMER

---



## **AVISO**

Este manual de assistência técnica encontra-se disponível unicamente em inglês.

(PT-BR)

- Se outro serviço de assistência técnica solicitar a tradução deste manual, caberá ao cliente fornecer os serviços de tradução.
  - Não tente reparar o equipamento sem ter consultado e compreendido este manual de assistência técnica.
  - A não observância deste aviso pode ocasionar ferimentos no técnico, operador ou paciente decorrentes de choques elétricos, mecânicos ou outros.
- 



## **ATENÇÃO**

Este manual de assistência técnica só se encontra disponível em inglês.

(PT-PT)

- Se qualquer outro serviço de assistência técnica solicitar este manual noutra idioma, é da responsabilidade do cliente fornecer os serviços de tradução.
  - Não tente reparar o equipamento sem ter consultado e compreendido este manual de assistência técnica.
  - O não cumprimento deste aviso pode colocar em perigo a segurança do técnico, do operador ou do paciente devido a choques eléctricos, mecânicos ou outros.
- 



## **ATENȚIE**

Acest manual de service este disponibil doar în limba engleză.

(RO)

- Dacă un furnizor de servicii pentru clienți necesită o altă limbă decât cea engleză, este de datoria clientului să furnizeze o traducere.
  - Nu încercați să reparați echipamentul decât ulterior consultării și înțelegerii acestui manual de service.
  - Ignorarea acestui avertisment ar putea duce la rănirea depanatorului, operatorului sau pacientului în urma pericolilor de electrocutare, mecanice sau de altă natură.
- 



## **ОСТОРОЖНО!**

Данное руководство по техническому обслуживанию представлено только на английском языке.

(RU)

- Если сервисному персоналу клиента необходимо руководство не на английском, а на каком-то другом языке, клиенту следует самостоятельно обеспечить перевод.
  - Перед техническим обслуживанием оборудования обязательно обратитесь к данному руководству и поймите изложенные в нем сведения.
  - Несоблюдение требований данного предупреждения может привести к тому, что специалист по техобслуживанию, оператор или пациент получит удар электрическим током, механическую травму или другое повреждение.
- 



## **UPOZORENJE**

Ovo servisno uputstvo je dostupno samo na engleskom jeziku.

(SR)

- Ako klijentov serviser zahteva neki drugi jezik, klijent je dužan da obezbedi prevodilačke usluge.
  - Ne pokušavajte da opravite uređaj ako niste pročitali i razumeli ovo servisno uputstvo.
  - Zanemarivanje ovog upozorenja može dovesti do povređivanja servisera, rukovaoca ili pacijenta usled strujnog udara ili mehaničkih i drugih opasnosti.
-

# LANGUAGE DISCLAIMER

---



## UPOZORNENIE

Tento návod na obsluhu je k dispozícii len v angličtine.

- (SK)
- Ak zákazníkovi poskytovateľ služieb vyžaduje iný jazyk ako angličtinu, poskytnutie prekladateľských služieb je zodpovednosťou zákazníka.
  - Nepokúšajte sa o obsluhu zariadenia, kým si neprečítate návod na obsluhu a neporozumiete mu.
  - Zanedbanie tohto upozornenia môže spôsobiť zranenie poskytovateľa služieb, obsluhujúcej osoby alebo pacienta elektrickým prúdom, mechanické alebo iné ohrozenie.
- 



## ATENCION

Este manual de servicio sólo existe en inglés.

- (ES)
- Si el encargado de mantenimiento de un cliente necesita un idioma que no sea el inglés, el cliente deberá encargarse de la traducción del manual.
  - No se deberá dar servicio técnico al equipo, sin haber consultado y comprendido este manual de servicio.
  - La no observancia del presente aviso puede dar lugar a que el proveedor de servicios, el operador o el paciente sufran lesiones provocadas por causas eléctricas, mecánicas o de otra naturaleza.
- 



## VARNING

Den här servicehandboken finns bara tillgänglig på engelska.

- (SV)
- Om en kunds servicetekniker har behov av ett annat språk än engelska, ansvarar kunden för att tillhandahålla översättningstjänster.
  - Försök inte utföra service på utrustningen om du inte har läst och förstår den här servicehandboken.
  - Om du inte tar hänsyn till den här varningen kan det resultera i skador på serviceteknikern, operatören eller patienten till följd av elektriska stötar, mekaniska faror eller andra faror.
- 



## OPOZORILO

Ta servisni priročnik je na voljo samo v angleškem jeziku.

- (SL)
- Če ponudnik storitve stranke potrebuje priročnik v drugem jeziku, mora stranka zagotoviti prevod.
  - Ne poskušajte servisirati opreme, če tega priročnika niste v celoti prebrali in razumeli.
  - Če tega opozorila ne upoštevate, se lahko zaradi električnega udara, mehanskih ali drugih nevarnosti poškoduje ponudnik storitev, operater ali bolnik.
- 



## DİKKAT

Bu servis kılavuzunun sadece ingilizcesi mevcuttur.

- (TR)
- Eğer müşteri teknisyeni bu kılavuzu ingilizce dışında bir başka lisandan talep ederse, bunu tercüme ettirmek müşteriye düşer.
  - Servis kılavuzunu okuyup anlamadan ekipmanlara müdahale etmeyiniz.
  - Bu uyarıya uyulmaması, elektrik, mekanik veya diğer tehlikelerden dolayı teknisyen, operatör veya hastanın yaralanmasına yol açabilir.
-

## 1. INTRODUCTION

This service manual is intended for use by qualified service technicians with the tools, facilities, and training to repair a medical device. For questions, contact International Biomedical.

### 1.1. Important Safety Considerations

Safety concerns or additional pertinent information will be displayed using warnings, cautions, and notes, having the following significance:



**Alerts to potential serious injury, adverse event, or safety hazard.**

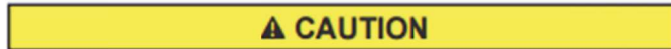

Alerts to the possibility of minor injury or damage to the equipment.

### NOTES:

*Provides additional information to clarify a point in the manual.*

The principal **WARNING** and **CAUTION** notices to be observed in use of this device are brought together here for emphasis.



Use of the AeroNOx 2.0™ is contraindicated for patients with congenital heart disease on right-to-left shunt, congenital anomalies, or congestive heart failure.

Do not use the AeroNOx 2.0™ in oxygen rich environments.

If an alarm occurs, safeguard patient before troubleshooting or repair procedures.

Use only pharmaceutical grade NO.

The AeroNOx 2.0™ must be used in accordance with indications, usage, contraindications, warnings, and cautions described in this manual.

The use of devices which radiate high intensity electrical fields may affect the operation of the AeroNOx 2.0™. Constant assessment of the patient and all life support equipment is mandatory whenever interfering devices are operating on or near patient.

When using the AeroNOx 2.0™ adjacent to or stacked with other equipment, observe the operation of the AeroNOx 2.0™ and the other equipment to ensure normal operation.

Portable RF communications equipment (including peripherals such as antenna cables and external antennas) should be used no closer than 30 cm to any part of the AeroNOx 2.0™ and associated cables. Otherwise, degradation of the performance of this equipment could occur.

Do not use the AeroNOx 2.0™ with helium/oxygen mixtures. The AeroNOx 2.0™ is only intended to deliver NO in conjunction with oxygen/air mixtures.

Anytime a new NO gas cylinder and regulator is used, the user must purge to prevent inadvertent delivery of NO<sub>2</sub> to the patient.

If the AeroNOx 2.0™ is not going to be used within 10 minutes, depressurize the regulator supply line.

If the AeroNOx 2.0™ is pressurized and not used within 10 minutes, repeat the purge procedure.

If the AeroNOx 2.0™ is not depressurized and not used within 12 hours, repeat the pre-use procedure.

A backup NO delivery system must always be available in the event the primary system should fail.

Set AeroNOx 2.0™ alarm thresholds for the current patient conditions to monitor any inadvertent changes in treatment. For alarm information, see the ALARMS section in the Operator's Manual (p/n 715-0086).

Be certain all lines and cables are organized to prevent damage or occlusion.

Use only parts, accessories, transducers, and cables designated by International Biomedical for use with the AeroNOx 2.0™. Cables and accessories other than those supplied by International Biomedical may result in unacceptable operation of the AeroNOx 2.0™ and will void the equipment warranty.

The AeroNOx 2.0™ samples gas at a rate of 220 mL/min; this can affect the sensitivity of flow triggered synchronized breath of some ventilators. The trigger sensitivity, if equipped, should be checked after connecting AeroNOx 2.0™ to the breathing circuit.

Do not change NO, NO<sub>2</sub>, or O<sub>2</sub> sensors while in use.

Do not attempt to maintain, diagnose, or repair the AeroNOx 2.0™ while delivering NO to a patient.

No modification of the AeroNOx 2.0™ is allowed.

Improper sensor or battery replacement will result in a non-functional or inaccurate device.

Sample/Delivery accessories are single patient use only. DO NOT re-use.

Improper maintenance or replacement of sensors may pose a safety risk to the patient. Maintenance should be performed by qualified service personnel per the instructions.

Perform cylinder connection and purge procedures in well-ventilated areas to prevent inadvertent exposure to Nitric Oxide or nitrogen dioxide gas. Follow your facility's safety procedures for handling medical gas cylinders.

Overexposure to NO or NO<sub>2</sub> can lead to physiological effects such as hypoxia which are not apparent to the operator.

The IP33 rating applies when the AeroNOx 2.0™ is on battery power with the DC Input jack properly sealed.

## CAUTION

Caution: U. S. Federal and Canadian law restricts this device to sale by or on the order of a physician or other licensed medical practitioner. Outside Canada and the U. S., check with local laws for applicable restrictions.

When using the AeroNOx 2.0™ Bagger or INOstat Bagger, oxygen and NO mix in the reservoir bag. If not actively bagging patient, turn NO flow off to prevent formation of NO<sub>2</sub>. Flush the bagger for 20 seconds before and after use to completely remove NO and NO<sub>2</sub>.

Concentrations of NO<sub>2</sub> in the reservoir bag may exceed 1 ppm. Large tidal volumes may expose patients to NO<sub>2</sub> in the reservoir bag. If any interruption occurs during patient bagging, system should be flushed for 20 seconds.

When using the AeroNOx 2.0™ Bagger or INOstat Bagger, short duration, rapid fluctuations in delivered gas concentration including NO<sub>2</sub> is possible. Therefore, the AeroNOx 2.0™ Bagger and INOstat Bagger are designed for short term use only.

Do not use AeroNOx 2.0™ Bagger or INOstat Bagger to deliver concentration in excess of 20 ppm. The generation of NO<sub>2</sub> increases rapidly above this concentration.

Do not alter the length of the INOstat Bagger gas supply tubing as this may cause generation of excessive levels of NO<sub>2</sub>.

Do not substitute AeroNOx 2.0™ Bagger or INOstat Bagger components. The Bagger Systems have been designed and tested for patient safety with the components included.

The AeroNOx 2.0™ Bagger and INOstat Bagger are intended to connect directly to the patient's endotracheal tube. Do not insert any additional tubing between the Bagger and the endotracheal tube.

The AeroNOx 2.0™ Bagger and INOstat Bagger are single patient use. Do not reprocess.

The INOstat Kit is intended for use if the primary NO delivery device (AeroNOx 2.0™) fails. The INOstat Kit is not intended as a primary NO delivery device.

The back-up delivery regulator in the INOstat Kit is preset with a 0.25 L/min flow. It is intended to be used only with the INOstat Bagger. Do not use this regulator for any other application.

Persons using the AeroNOx 2.0™ should be trained and experienced in the use of this device to assure effective administration of NO, and to avoid injury to the patient or to others resulting from inhalation of excess NO, NO<sub>2</sub>, or other reaction products. Not for use by patients.

Persons using this device who may be particularly sensitive to Nitric Oxide or nitrogen dioxide, or who may be exposed to these gases for prolonged periods as a result of the use of this device, should be aware that the AeroNOx 2.0™ does not scavenge the exhaust gas, and that this gas is vented from the underside of the AeroNOx 2.0™, or through the side vent in the event that the bottom port is occluded. Ambient concentrations of Nitric Oxide or nitrogen dioxide expected to result from the use of this device are less than 50 ppb.

Only use International Biomedical approved batteries for AeroNOx 2.0™.

Even when the external power supply is not connected, the battery provides a bias charge to the NO, NO<sub>2</sub>, and O<sub>2</sub> cells to keep sensors in a ready state. The power drawn from biasing the sensors will deplete a new fully charged battery in approximately one week. Because of this, it is recommended the external power supply of the AeroNOx 2.0™ remain plugged in at all times to maintain battery charge.

Disconnect the battery or leave charging when not in use for extended periods of time.

Allowing the battery to fully discharge repeatedly will reduce the overall number of cycles in the life of the battery.

Attempting to run the AeroNOx 2.0™ for longer than five hours on battery only could result in an interruption of Nitric Oxide therapy.

The specified power supply is defined as part of the ME Equipment. Use only the International Biomedical approved universal power supply for AeroNOx 2.0™.

No other devices are known to cause potential interference with the AeroNOx 2.0™. If interference occurs, discontinue use of the AeroNOx 2.0™ and use the INOstat Bagger.

Never turn on the NO delivery gas without first turning on the ventilator or bagger flow. Failure to do this will result in undiluted gas delivery entering the sampling chamber and exposing the sensors to levels of NO and /or NO<sub>2</sub> which may damage the sensors.

NO<sub>2</sub> gas may have collected in the AeroNOx 2.0™ delivery or ventilator circuit during setup. Run ventilator and AeroNOx 2.0™ on a test lung 30 seconds prior to patient connection to ensure analyzed levels of NO<sub>2</sub> and NO are appropriate.

Only use the NO Worries Sample line with filter and Nafion® tubing when operating the AeroNOx 2.0™. Failure to do so may result in the egress of moisture which can impair function as well as damage internal components.

NO flow must be continually evaluated during Nitric Oxide administration to ensure accurate dosing.

NO cannot be administered during the calibration process.

Do not sterilize or disinfect with power connected.

Allow unit to dry thoroughly before use. Immediate use after exposure to excessive cleaning agents such as Isopropyl Alcohol can affect sensor performance.

Do not push on LCD display.

The VESA 75 mount is required for mounting during transport.

Should there be a sudden need to change therapy tanks; a second tank should always be purged and ready for immediate use. Perform the purge procedure immediately upon installation of a new regulator.

The flush procedure must be performed each time NO therapy is started. This includes initial therapy starts, tank changes, and re-starting therapy after NO has been off.



Powering the unit off will shut off the delivery gas flow. Gas flow is terminated when the unit is powered off, whether intentionally, or during a complete loss of power.

DO NOT exceed 2.00 LPM as displayed on the AeroNOx 2.0™ flow display. Displayed values in excess of 2.00 LPM are not accurate. If the flow on the AeroNOx 2.0™ flow meter is set at a value greater than 2.00 LPM, the delivered flow will be higher than the displayed flow value.

The NO<sub>2</sub> sensor may easily be damaged by inadvertent high levels of NO<sub>2</sub>. Use Nitrogen or air to flush the system after high levels of NO (> 100 ppm) or NO<sub>2</sub> (> 20 ppm) have been introduced to the sensor.

Setting alarm limits to extreme values can render the alarm system useless.

After storage at the extremes of the allowable temperature range, it is recommended that the AeroNOx 2.0™ be given at least an hour at room temperature before use.

### **NOTES:**

*The Low Cal does not require calibration gases.*

*Connections to various ventilators are unique to each manufacturer as well as their corresponding disposable circuits.*

*When AeroNOx 2.0™ is connected to a ventilator and patient is breathing spontaneously, a slight change in NO ppm (< 10%) may be noted.*

*When performing high range calibration, make sure to select the correct calibration gas and confirm expiration date before using.*

*Never connect calibration circuit to a pressure source > 50 cm H<sub>2</sub>O; this could damage the sampling system.*

*Protective cover not shown in many images throughout this manual should be used at all times to provide extra impact resistance if dropped.*

*AeroNOx 2.0™ is shipped with battery uninstalled. Follow installation procedure in Section 7.*

*Do not mount or position the AeroNOx 2.0™ such that the rear power connection, exhaust ports, or the NO inlet are blocked.*



















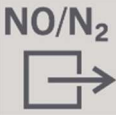
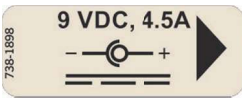
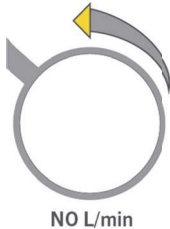

*The recommended storage temperature limits are within operational temperature limits to preserve sensor life. No specific time to cool or warm from storage temperature extremes is indicated. Before normal use, a pre-check must be performed to allow sensors to stabilize.*



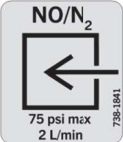
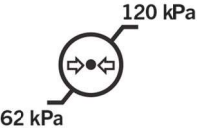













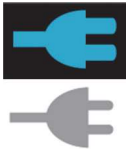

*Use the tethered rubber plug to seal the DC input jack from the environment when not in use.*

## 2. SPECIFICATIONS

### 2.1. Symbols Table

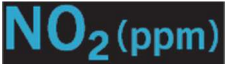
The following symbols appear in the AeroNOx 2.0™ documentation and labels.

	"ON"/"OFF" Power (Hold for ~3 Seconds to turn off)		Soft Key (3)
	Silence Alarm Button		Date of Manufacture
	Dim Backlight Button		Manufacturer contact information
	Back Button		General Warning, Caution, Risk of Danger
	NO Sample Inlet		Do not discard in trash
	NO/N <sub>2</sub> Delivery Outlet		Use indicated power supply only
	Nitric Oxide Flow Control (Increasing flow counter clockwise)		Exhaust Do Not Block
	ATTENTION: Observe precautions for handling electrostatic sensitive devices.		Use only the specified replacement battery.
	Consult Instructions For Use		NO/N <sub>2</sub> Supply Gas Input
	Operating pressure limits		Operating temperature limits
	Type BF Applied Part		Class II Equipment
	Device serial number		Prescription use only

	Device part number		Decrease Value
	Confirmation		Set Low Alarm Limit
	Select High/Low Alarm Limits		Set High Alarm Limit
	Increase Value		AC Power Plugged in and Charging
	Alarm Temporarily Silenced for Approximately 60 Seconds		Screen Lock
	Battery Level Full / Low		Screen Unlock (Hold to unlock)
	Hold Button Timer (Moving Pie Chart)		Lock Prohibited with unacknowledged alarm
	Nitric Oxide Concentration in Parts Per Million		Percent Oxygen
	Nitrogen Dioxide Concentration in Parts Per Million		Zero Calibration Screen Soft Key
	Set NO=0, NO <sub>2</sub> =0, and %O <sub>2</sub> =21 Soft Key (Hold to zero)		High Calibration Screen Soft Key

## 2.2. Abbreviations

ABBREVIATION	DEFINITION
AC	Alternating Current
CISPR	International Special Committee on Radio Interference
cm	Centimeters
DC	Direct Current
ESD	Electrostatic Discharge
FiO <sub>2</sub>	Fraction of Inspired Oxygen
FSO	Full Scale Output
ft	Feet
HFOV	High Frequency Oscillatory Ventilation
IB	International Biomedical
in	Inches
L/min	Liters per Minute
mA	Milliamps
mbar	Millibars
mL/min	Milliliters per Minute
mm	Millimeters
mmHg	Millimeters of Mercury
N <sub>2</sub>	Nitrogen Gas
NO	Nitric Oxide Gas
NO <sub>2</sub>	Nitrogen Dioxide Gas
O <sub>2</sub>	Oxygen Gas
PM	Preventative Maintenance
ppb	Parts per billion
ppm	Parts Per Million
psi	Pounds per Square Inch
psig	Pounds per Square Inch Gauge
PTFE	Polytetrafluoroethylene
RH	Relative Humidity
RF	Radio Frequency
V	Volts
VESA	Video Electronics Standards Association
VRLA	Valve Regulated Lead Acid

### 2.3. Ventilator Compatibility

The AeroNOx 2.0™ has been validated with the following ventilators:

#### **Conventional:**

1. Bio-Med Devices MVP-10 (CMV/IMV Mode)
2. Bio-Med Devices CV2i+ (CMV/IMV Mode)
3. Accutronic Fabian/TV-1 Evolution (IPPV Mode)
4. HAMILTON-T1 (PCV Mode)
5. Bio-Med Devices TV-100 (IPPV Mode)

#### **High Frequency:**

1. Percussionaire TXP-2D (frequencies between 5 Hz (300 bpm) and 8.3 Hz (500 bpm) and amplitude less than 30 cmH<sub>2</sub>O with mean airway pressures of 8-18 cmH<sub>2</sub>O)

### 2.4. Measurement Range and Accuracy

Parameter	Measurement Range	Meter Resolution	Sensor Accuracy	Device <sup>1</sup> Accuracy
NO	0-99 ppm	1 ppm	± 1 ppm	± 2 ppm
NO <sub>2</sub>	0-9 ppm	0.1 ppm	± 0.1 ppm	± 2 ppm
O <sub>2</sub>	18-100%	± 1% O <sub>2</sub>	± 2% O <sub>2</sub>	± 3% O <sub>2</sub>
NO/N <sub>2</sub> Flow	0-2 L/min	0.01 L/min	± 0.045 L/min	± 0.1 L/min

### 2.5. Backup Delivery Regulator

Parameter	Specification
Inlet Pressure	500-2250 psi
Outlet Flowrate	0.25 L/Min Fixed flow of NO/N <sub>2</sub>
Cylinder Valve Connection	CGA 626

### 2.6. INOstat Bagger

Parameter	Specification
O <sub>2</sub> Gas Flow	10 L/Min
NO Gas Flow	0.25 L/Min
Delivered NO	20 ppm
NO <sub>2</sub> Generated	0.2 ppm Maximum 20 ppm NO Delivered
Reservoir Volume	0.5 L
Bagger Dimensions	Approximately 30 cm length
Tidal Volume	500 ml Max Tidal Volume
Breath Rate	Maximum 100 bpm at PIP 18 cmH <sub>2</sub> O PEEP 5 cmH <sub>2</sub> O. Maximum 50 bpm at PIP 40 cmH <sub>2</sub> O PEEP 5 cmH <sub>2</sub> O
I:E Ratio	Variable

<sup>1</sup> Device accuracy is affected by the ventilator that is attached.

2.7. AeroNOx 2.0™ Delivery Regulator

Parameter	Specification
Inlet Pressure	500-2250 psi
Outlet Pressure	45-75 psi
Cylinder Valve Connection	CGA 626

2.8. AeroNOx 2.0™ Physical Specifications

Parameter	Specification
Weight (device + protective cover only)	4.4 kg
W × D × H	33 cm × 14 cm × 25 cm
Precision Metering Valve	~12 turns to fully open
Service Life	8 years with preventative maintenance
Gas Supply	Recommend NO @ 800ppm Balance N <sub>2</sub>
Alarm Sound Pressure Level	High Alarm - 56dB Max @ 1m Medium Alarm - 54dB Max @ 1m

2.9. AeroNOx 2.0™ Environmental Specifications

	Operating	Transport/Storage	Transient
Temperature	0° C to 39° C	-40° C to 5° C 5° to 35° C up to 90% RH 35° C to 70° C vapor pressure up to 50hPa	-20° C to 50° C
Humidity	15-90% RH non-condensing	See above	15-90% RH non-condensing
Ambient Pressure	62-120 kPa	62-120 kPa	Not rated
Altitude	3657 m (12,000 ft)	3657 m (12,000 ft)	Not rated
Ingress Protection AeroNOx 2.0™ Power Supply	IP33 <sup>2</sup> IP22 <sup>3</sup>	IP33 <sup>2</sup> IP22 <sup>3</sup>	Not rated Not rated

<sup>2</sup> (Falling liquid spray 60° from vertical for 5 min and 2.5 mm object protection)

<sup>3</sup> (Dripping water at 15° from vertical for 2.5 min, and 12.5 mm object protection)

## 2.10. AeroNOx 2.0™ Electrical Specifications

Parameter	Specification
Medical Rated AC Supply	Meanwell GSM40B09-P2S
Input Fuse	3A Self-resetting
Classification	Class II, 2 X MOPP
AeroNOx 2.0™ Input Voltage	120 - 240 VAC, 50/60 Hz
Battery	Sealed lead acid 6 V, 4.5 Ah battery provides standalone power for 5 hours. IB P/N 888-0115, 1 year life
<b><i>NOTE:</i></b> Batteries are not interchangeable.	LiFePO <sub>4</sub> 6.4 V, 4.5 Ah battery provides standalone power for 5 hours. IB P/N 888-0013, 2 year life
Standards	<ol style="list-style-type: none"> <li>60601-1 (General Requirements for basic safety and essential performance)</li> <li>60601-1-2 (Electromagnetic Compatibility)</li> <li>60601-1-8 (Alarms)</li> <li>60601-1-12 (EMS Environment)</li> </ol>

## 2.11. Sensor Specifications

	NO	NO <sub>2</sub>	O <sub>2</sub>	Flow
Max Overload	1500 ppm	200 ppm	N/A	N/A
Linearity	Linear	Linear	< 3% error	N/A
Response Time (T <sub>90</sub> )	<10s	<50s	≤ 13 s	10ms
Effect of Temp on Accuracy	N/A	N/A	N/A	Compensated 0 to 50° C

For further sensor details visit the datasheets in the Appendix.

## 2.12. EMC Compliance

The AeroNOx 2.0™ has been tested and found to comply with limits for electromagnetic interference and susceptibility as defined by IEC60601-1-2. However, this equipment may radiate radio frequency (RF) energy and may cause harmful interference to other devices. The AeroNOx 2.0™ is intended for use in an electromagnetic environment in which radiated RF disturbances are controlled. The customer or the user of the AeroNOx 2.0™ can help prevent electromagnetic interference by maintaining operating the device in the environments and with the minimum separation distances specified below. Additionally, periodic maintenance as specified by International Biomedical will allow the device to continue to provide basic safety and essential performance.

## GUIDANCE AND MANUFACTURER'S DECLARATION - EMISSIONS

The AeroNOx 2.0™ is intended for use in the electromagnetic environment specified below. The customer or user of the AeroNOx 2.0™ should ensure that it is used in such an environment.

EMISSIONS TEST	COMPLIANCE	ELECTROMAGNETIC ENVIRONMENT - GUIDANCE
RF Emissions CISPR 11	Group 1	The AeroNOx 2.0™ does not use RF energy for its internal function. Therefore, its RF emissions are very low and are not likely to cause any interference in nearby electronic equipment.
Conducted Emissions CISPR 11	Class B	The AeroNOx 2.0™ is suitable for use in all establishments, including domestic, and those directly connected to the public low-voltage power supply network that supplies buildings used for domestic purposes.
Harmonics IEC 61000-3-2	Class A	
Flicker IEC 61000-3-3	Complies	
RTCA/DO-160F Section 21	Category M	Maximum level of conducted RF interface-Power line
RTCA/DO-160F Section 21	Category M	Maximum level of radiated RF interface

## GUIDANCE AND MANUFACTURER'S DECLARATION - IMMUNITY

The AeroNOx 2.0™ is intended for use in the electromagnetic environment specified below. The customer or user of the AeroNOx 2.0™ should ensure that it is used in such an environment.

IMMUNITY TEST	IEC 60601 TEST LEVEL	COMPLIANCE LEVEL	ELECTROMAGNETIC ENVIRONMENT - GUIDANCE
ESD IEC 61000-4-2	± 8 kV Contact ± 2/4/8/15 kV Air	± 8 kV Contact ± 2/4/8/15 kV Air	Floors should be wood, concrete, or ceramic tile. If floors are synthetic, the r/h should be at least 30%.
Surge IEC 61000-4-5	± 0.5/1 kV Differential ± 0.5/1/2 kV Common	± 0.5/1 kV Differential ± 0.5/1/2 kV Common	Mains power quality should be that of a typical commercial or hospital environment.
Power Frequency 50/60 Hz Magnetic Field IEC 61000-4-8	30 A/m	30 A/m	Power Frequency magnetic fields should be that of a typical commercial or hospital environment.



## GUIDANCE AND MANUFACTURER'S DECLARATION - IMMUNITY

The AeroNOx 2.0™ is intended for use in the electromagnetic environment specified below. The customer or user of the AeroNOx 2.0™ should ensure that it is used in such an environment.

IMMUNITY TEST	IEC 60601 TEST LEVEL	COMPLIANCE LEVEL	ELECTROMAGNETIC ENVIRONMENT - GUIDANCE
Conducted RF IEC 61000-4-6	3 Vrms 150 kHz to 80 MHz (AC/DC)	3 Vrms 150 kHz to 80 MHz (AC/DC)	Portable and mobile communications equipment should be separated from the AeroNOx 2.0™ by no less than the distances calculated/listed below:  $D = \frac{3.5}{V_1} \sqrt{P}$
	6 Vrms (in ISM Bands between 150kHz and 80MHz)	6 Vrms (in ISM Bands between 150kHz and 80MHz)	$D = \frac{3.5}{E_1} \sqrt{P}$ 80 to 800 MHz  $D = \frac{7}{E_1} \sqrt{P}$ 800 MHz to 2.7 GHz
Radiated RF IEC 61000-4-3	10 V/m 80 MHz to 2.7 GHz	10 V/m 80 MHz to 2.7 GHz	Where P is the max power in watts and D is the recommended separation distance in meters.
		(V <sub>1</sub> ) Vrms  (E <sub>1</sub> ) V/m	Field strengths from fixed transmitters, as determined by an electromagnetic site survey, should be less than the compliance levels (V <sub>1</sub> and E <sub>1</sub> ).  Interference may occur in the vicinity of equipment containing a transmitter.
Proximity fields from RF Wireless Communication Equipment IEC61000-4-3	See IEC60601-1-2:2014 8.10	See IEC60601-1-2:2014 8.10	This equipment should be placed no closer than 30cm from the nearest RF Wireless communication device.

## 2.13. Physical Dimensions and Center of Mass

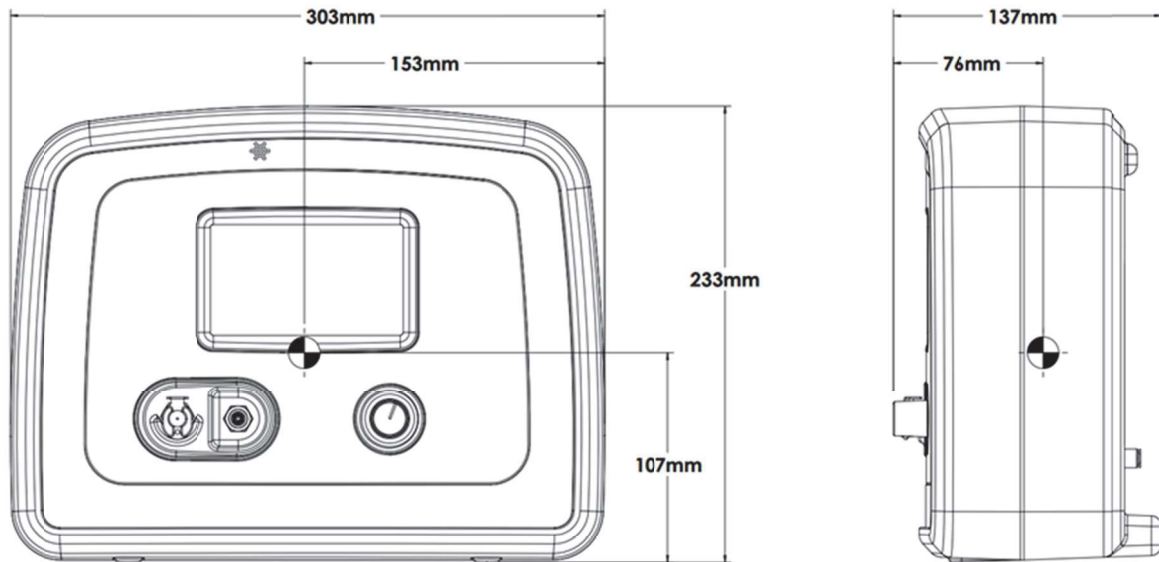

MASS = 4.4 kg

## 2.14. VESA Mounting Pattern

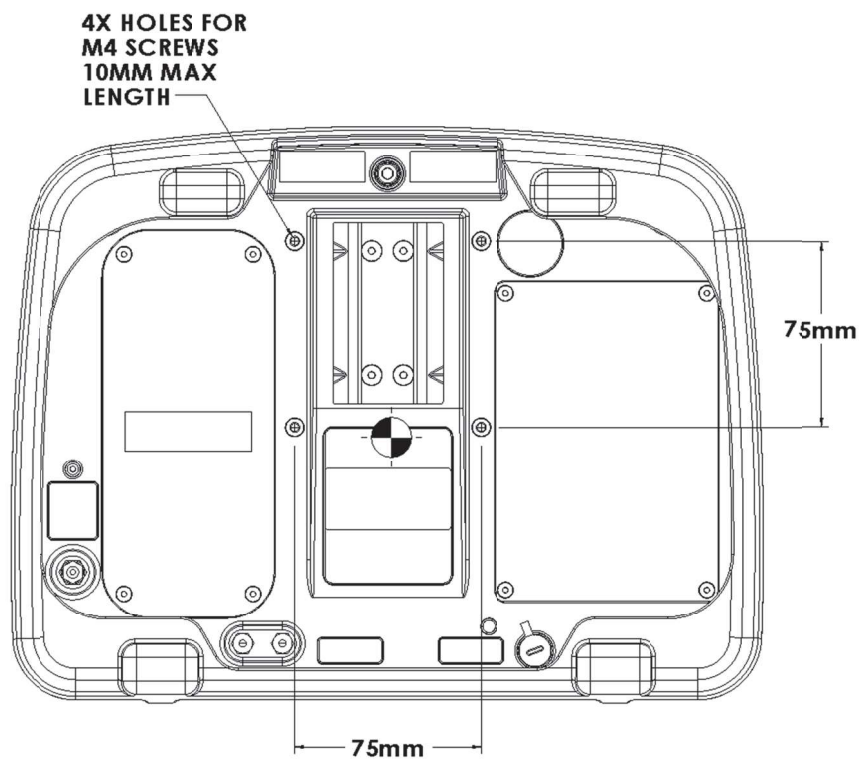

### 3. THEORY OF OPERATION

The AeroNOx 2.0™ is a durable, light-weight, portable, battery operated device designed to deliver Nitric Oxide (NO) to a ventilator circuit and continuously monitor and display concentration levels of Nitric Oxide, Nitrogen Dioxide (NO<sub>2</sub>), and Oxygen (O<sub>2</sub>).





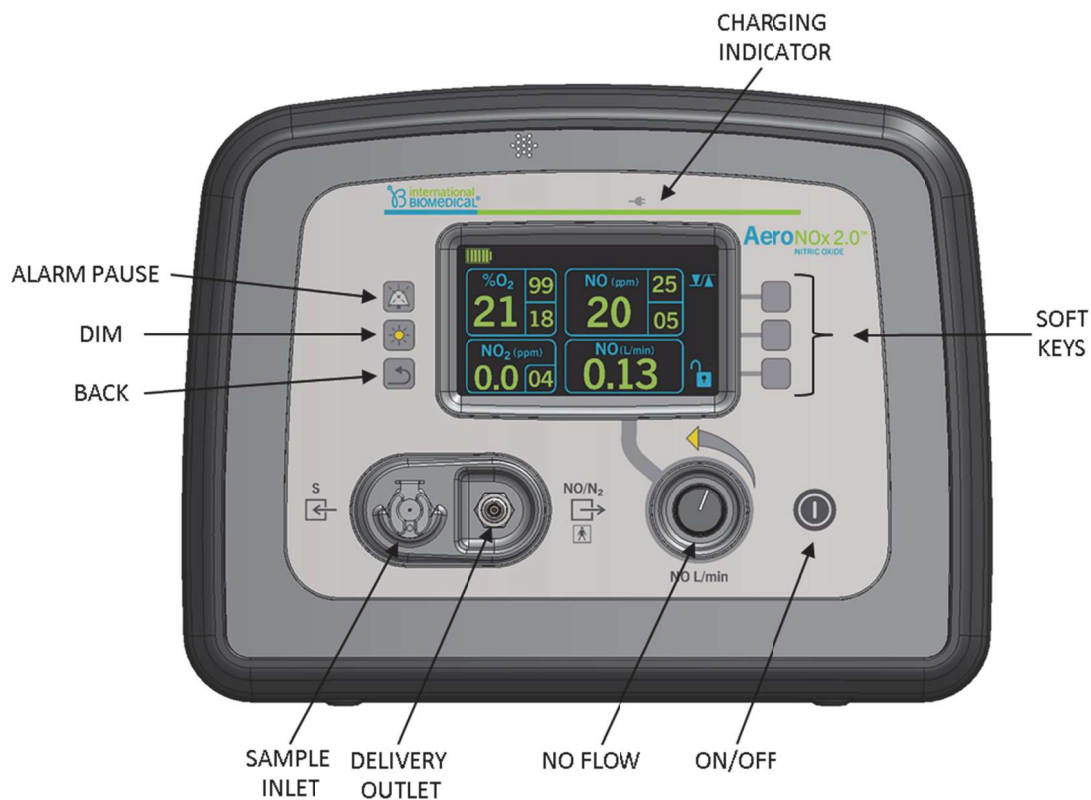

#### 3.1. Front Panel

The front panel contains a 4.3" smart display and a dedicated green LED for indicating that the device is plugged in. Six push buttons located on the front panel allow setting of the High and Low concentration alarm points for NO and O<sub>2</sub> and the High concentration alarm point for NO<sub>2</sub>. The right three buttons are soft keys that have varying function depending on which menu is displayed. The three left push buttons are dedicated to "Alarm Pause", "Screen Dim", and "Back" functions. The manual flow control knob is located toward the lower right side of the front panel. The On/Off button is located in the lower right corner.

#### 3.2. Front View - Labeled



### 3.3. Button Functions

BUTTON	FUNCTION
	<ul style="list-style-type: none"> <li>• Turn on/off device (Hold for ~3 Seconds to turn off)</li> </ul>
	<ul style="list-style-type: none"> <li>• Silences current alarms for 60 seconds and displays the “Alarm Pause” icon in the upper right hand corner of the display</li> </ul>
	<ul style="list-style-type: none"> <li>• Toggles between high brightness and low brightness for operation in darker environments</li> </ul>
	<ul style="list-style-type: none"> <li>• Returns the user to the previous menu</li> <li>• Enter calibration when held during the startup screen</li> </ul>
	<ul style="list-style-type: none"> <li>• Hold together for ~5 seconds to enter “Safety Off” Mode</li> </ul> <p><b><u>WARNING:</u> Safety features have been disabled for setup or troubleshooting. Do not enter “Safety Off” mode with patient connected.</b></p>
	<p>Depending on the adjacent icon displayed on the screen this button may:</p> <ul style="list-style-type: none"> <li>• toggle the calibration mode,</li> <li>• toggle the selected gas</li> <li>• zero the sensors</li> <li>• lock/unlock the buttons</li> <li>• toggle high/low alarm setting</li> <li>• increase/decrease selected value</li> </ul>

### 3.4. Rear Panel

The battery, sensors, charging port, NO inlet, and mounting points are accessed from the rear of the device. See the following view for respective locations.

### 3.5. Rear View - Labeled

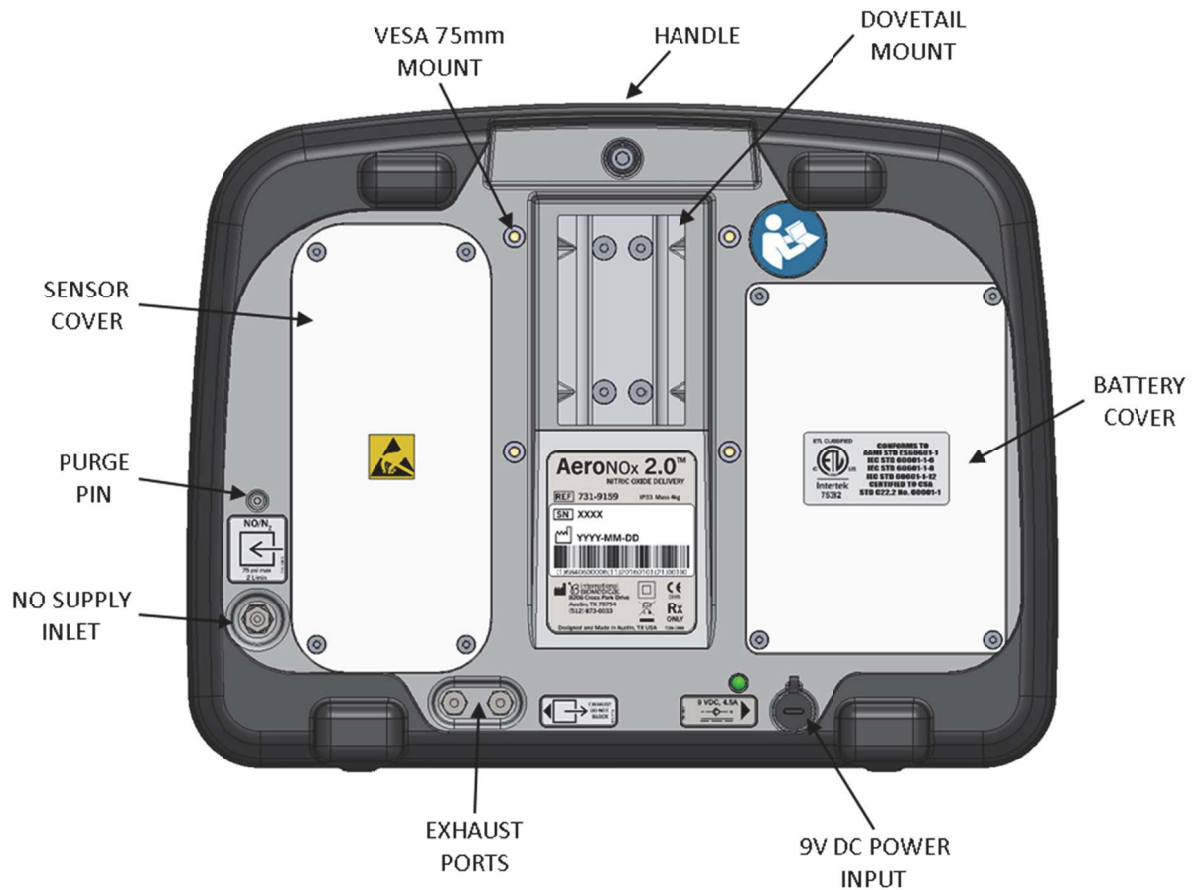

### 3.6. Connection to Ventilator Circuit

The system is divided into a delivery side and a sampling side. The delivery side uses a precision valve to manually control the flow of pre-mixed medical grade Nitric Oxide and Nitrogen, while an in-line mass flow meter measures the flow rate. The NO flow is injected into a ventilator circuit where it mixes with ventilator flow and reduces in concentration to the prescribed value (e.g., 800 ppm NO/N<sub>2</sub> reduces to 20 ppm in 5 L/min of Oxygen). Downstream on the ventilator circuit, the AeroNOx 2.0™ diverts a sample of the mixture to verify its concentration as delivered to the patient. To adjust the concentration, the user must manually increase or decrease the flow of NO/N<sub>2</sub> via the control knob on the front panel. Measurements of NO, NO<sub>2</sub>, O<sub>2</sub>, and flow rate are displayed continuously, as well as alarms, indications, and warning messages. The NO/N<sub>2</sub> flow and resultant sampled NO concentration are related given the ventilator flow rate and NO/N<sub>2</sub> concentration, so the user can cross check the NO concentration for expected values. The diagram below shows a typical setup. NO<sub>2</sub> is measured as it is a toxic byproduct of highly reactive NO and O<sub>2</sub> when left lingering too long together.

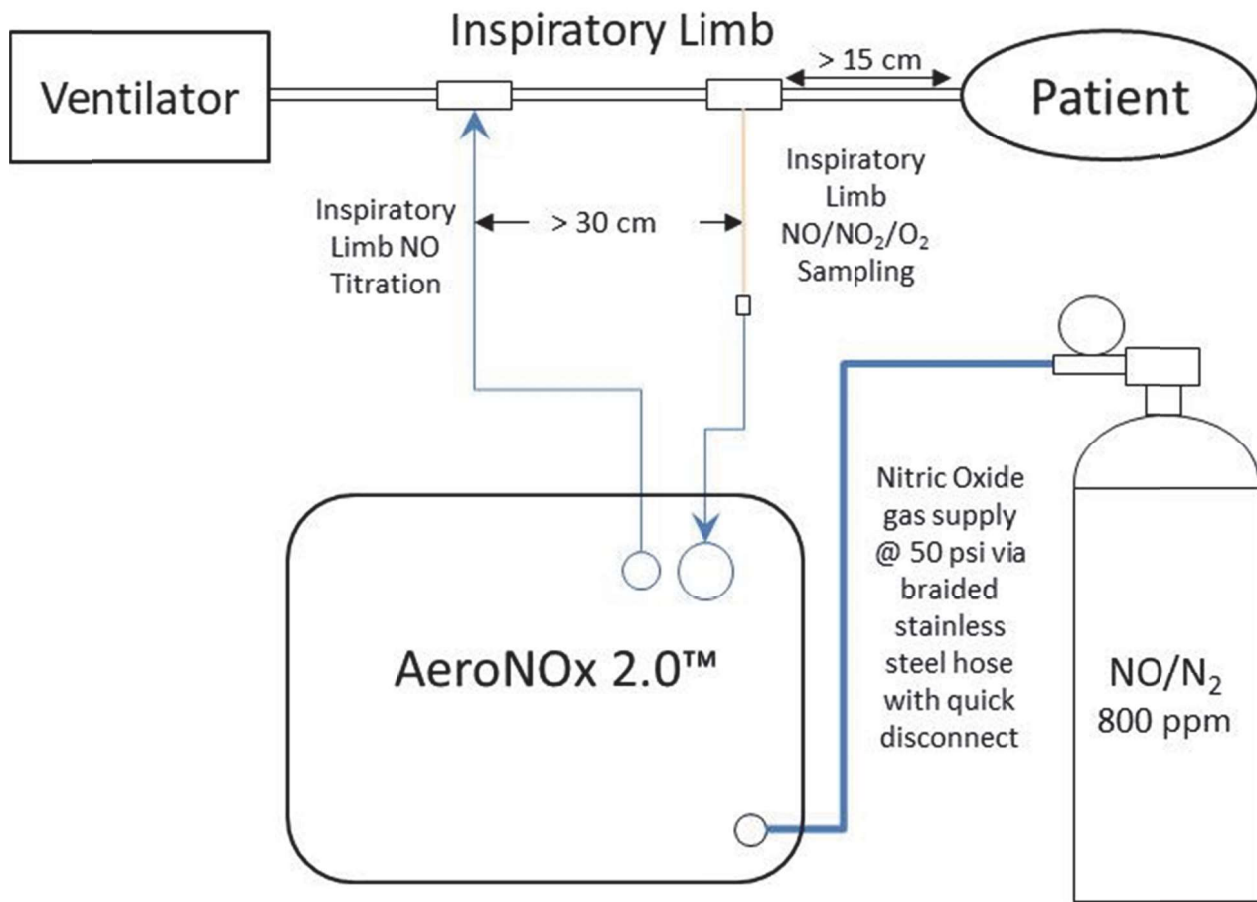

The following figure describes the pneumatic flow paths for both the sample and the delivery side of the device when connected to a ventilator.

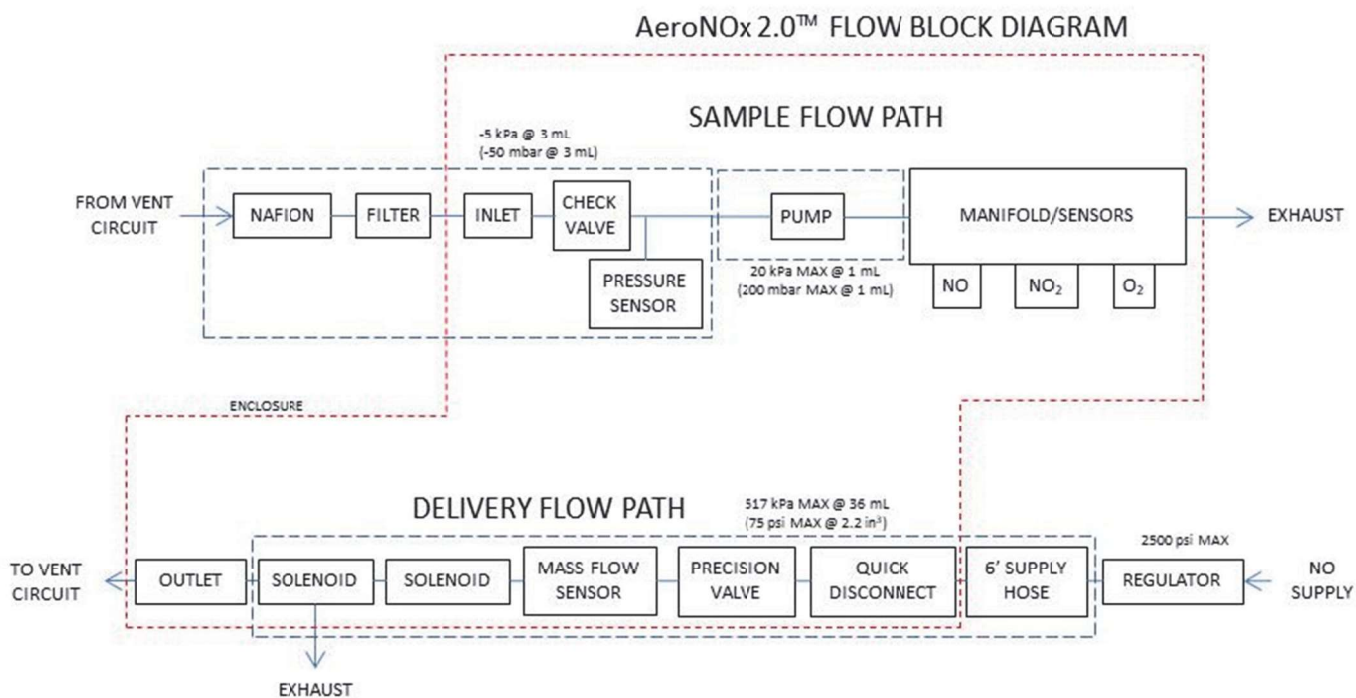

### 3.7. Delivery System

Regulated 50 psi Nitric Oxide is supplied to the 'NO/N<sub>2</sub> Inlet' quick disconnect through a braided stainless steel hose. This feeds into the manual flow control valve in the instrument. This valve controls the delivery rate of the Nitric Oxide and is operated by the plastic knob on the front panel of the device. From the valve, the Nitric Oxide flows through a 0-2 L/min Mass Flow Meter. Gas NO/N<sub>2</sub> then enters the solenoid valve assembly with states shown below. The first in the series opens and closes with the operation of the power switch, and its function is to ensure that no gas can flow if the power switch is turned off. A second valve, in series with the first, activates for about 1 second when the power switch is turned on. This valve diverts the flow of Nitric Oxide to room air exhaust for ~1 second to release the pressure built up by the gas stored in the mass flow meter. It then switches to pass the gas through to the "Nitric Oxide Delivery Outlet". The microprocessor in the instrument controls the operation of the solenoid valves.

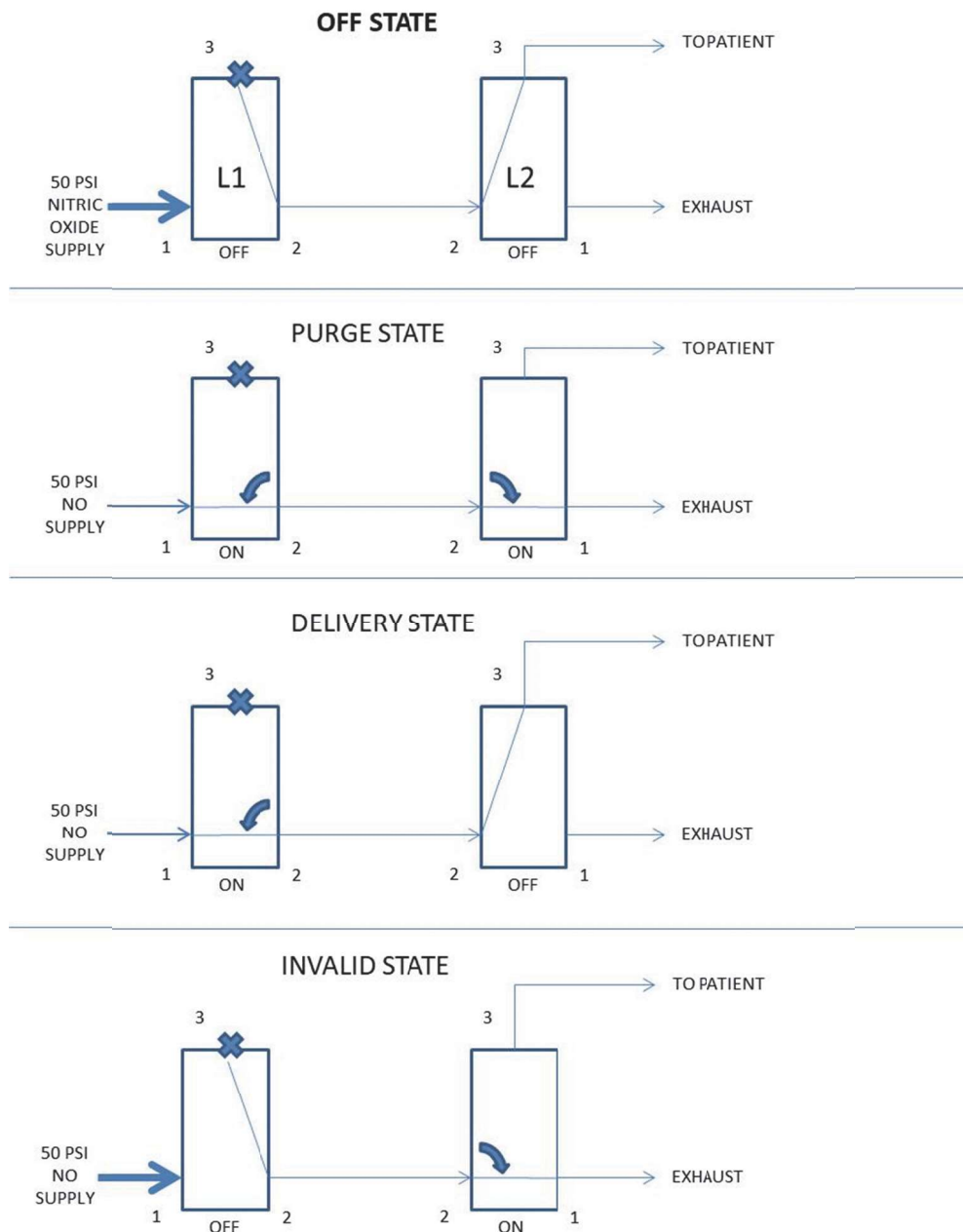

### 3.8. Sample Analysis System

Gas for analysis is drawn into the device via a sample circuit with Nafion<sup>®</sup> tubing into the filtered “Sample Inlet” quick disconnect. From here, it passes through a check valve, a tee to the pressure transducer, the sample pump, and into the manifold. The differential pressure transducer monitors the line attached to the “Sample Inlet” for obstructions. If vacuum pressure goes below 50 mbar, the pressure transducer signal is used to shut off the pump, shut down NO/N<sub>2</sub> flow, and warn the user. Power must be cycled to reset the device after a “Sample Blocked” condition has occurred. An internal potentiometer adjusts the pump RPM to set the sample flow rate to ~200 mL/min. As the gas exits the pump, it flows through a manifold where it travels past the oxygen, nitrogen dioxide, and nitric oxide sensors before being exhausted to room air. Signals from the oxygen, nitrogen dioxide, and nitric oxide sensors are sent to the microprocessor for display on the LCD display on the front of the device. The sampling system operating range is shown below as well as an isometric view of the Sample/Delivery System components inside the AeroNOx 2.0™.

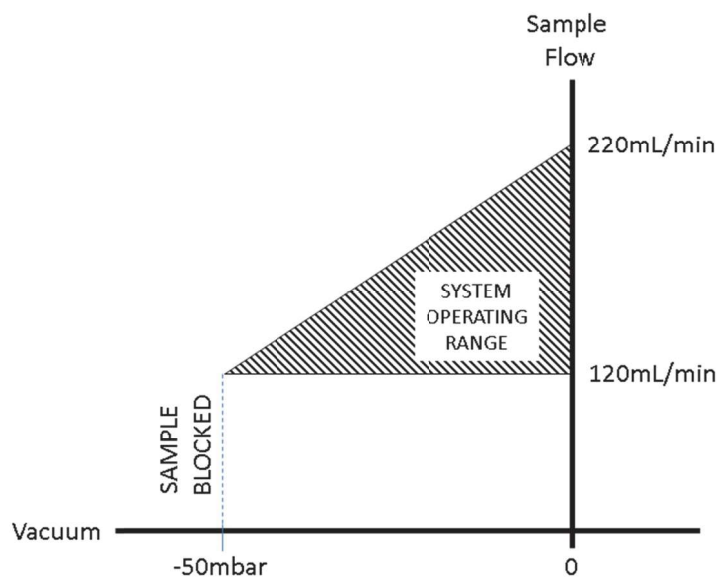
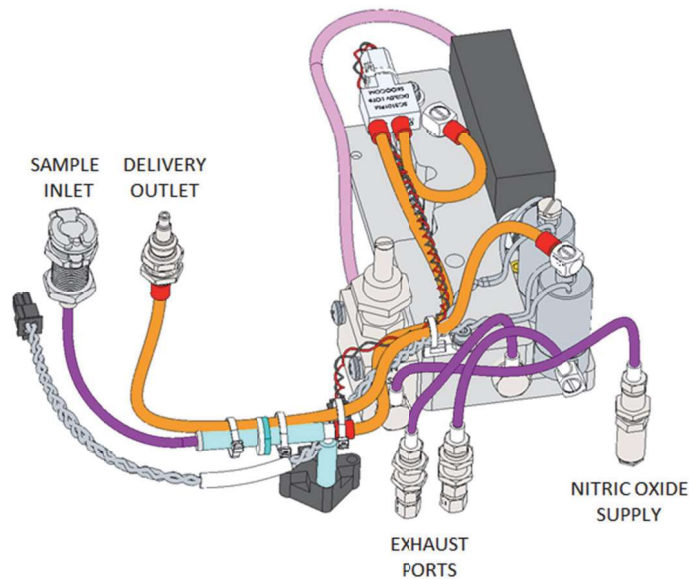



### 3.9. General Features and Operation

#### 3.9.1. **Microprocessor**

The AeroNOx 2.0™ is designed around the TEKMOS TK68HC711E9CFNE3 microprocessor operating with a clock frequency of 3MHz. The microprocessor and associated software are responsible for the NO and NO<sub>2</sub> analysis operations and the delivery of NO. Firmware may only be updated by International Biomedical.

#### 3.9.2. **4.3” Smart LCD**

The display is a smart 4.3” LCD that contains graphics and subroutines called by the TEKMOS processor. The display may only be replaced. Attempting to access the USB port may harm the device and render it inoperable.

#### 3.9.3. **Startup**

The AeroNOx 2.0™ is turned on by pressing the power switch on the front panel. Activating this switch awakens the microprocessor from its “sleep” mode. A battery voltage and a Read only Memory (ROM) check are performed. If all is well, the microprocessor (U7) activates the LCD display with a message containing the model and the current software version showing for about 4 seconds, then defaulting to delivery mode where flow rate and concentrations of NO, O<sub>2</sub>, and NO<sub>2</sub> are shown. The ‘SYS\_ON’ signal is also fed to the power supply circuit board, enabling transistor Q1, which now pulls U3-2 low. This now takes the regulator U3 out of “shutdown”, bringing the main +5 volt supply online. At this point, the instrument is completely powered up and functioning, the O<sub>2</sub> and flow displays are on, and the sample pump has started and is running.

Holding down the front panel power button will turn the unit off. When the unit is “off”, portions of the instrument are still powered up but the microprocessor is put into a “sleep” mode. Power is still applied to the microcontroller, the power button circuit, the Analog to Digital converters, and to the analog power supplies. The Analog to Digital converters are in a power down mode with very small current consumption when the instrument is off. In addition to some circuits on the control board, the analog power supplies also support the sensor board. Power is required to maintain a bias voltage of -300 mV on the NO sensor. If this bias is lost, several hours are required before the NO sensor can be used to measure gas accurately. More information on the sensors is provided later in this manual. Maintaining the bias on the NO sensor means the instrument is ready for calibration and use immediately upon powering up. The NO<sub>2</sub> sensor does not require this constant bias when the unit is off; instead, a set of contacts on the power switch close when the switch is turned off, placing a short circuit across the SENSE and REFERENCE electrodes of the cell. This keeps the NO<sub>2</sub> sensor in a ready-to-use condition.

On the power supply board, U3 remains powered, although U3 draws little current in its “shutdown” condition. If the external DC supply is connected, the associated charge circuit and VDC regulator (U8) will function regardless of unit power state.

### 3.9.4. **Battery, Charger, and Battery Monitor**

The software in the AeroNOx 2.0™ monitors the condition of battery charge and displays it on the LCD display in the upper left hand corner. In addition, it also determines if there is sufficient power to correctly operate the instrument.

There are two battery options used in the AeroNOx 2.0™. The first is a sealed lead-acid battery rated at 6V, 4.5 Ah. The second is a 6.4V, 4.5Ah LiFePO<sub>4</sub> battery. The battery is modified with a low voltage cutoff and overcurrent protection circuit in series with the positive lead. The SLA battery has a 2-pin connector and the LiFePO<sub>4</sub> has a 3-pin connector. Only use the International Biomedical approved replacement batteries 888-0115 (SLA) or 888-0013 (LiFePO<sub>4</sub>).

The AeroNOx 2.0™ was designed to be charged and operated with a medical grade power supply (P/N 738-1964). Intelligent charging circuitry for the battery is provided on the power supply board. This is sufficient to fully power the unit and charge the battery, while preventing overcharging of a powered-off unit with a depleted battery. Polarity protection is also provided in the event an unapproved external power source is attached. If the battery discharges to the cut-off point, the battery may appear completely dead unless charged above the cut-off voltage or left to spontaneously rebalance its internal charge.

During operation, the battery level is monitored, as well as the external power input. If the AeroNOx 2.0™ is being externally powered, a symbol representing a 2-prong power plug is displayed in the upper left-most position of the LCD display. When operating from the internal battery only, this character is replaced with a battery bar. A fully charged battery will be indicated by the presence of all bars, which will gradually change color and disappear to become an empty outline of the battery. As the battery voltage drops through critical thresholds, the messages "**LOW BATTERY**", "**DATA INVALID**", "**CONNECT CHARGER**", and "**NITRIC OFF**" will appear on the screen. Eventually, the unit shuts off completely.

### 3.9.5. **Alarms, Messages, and Warnings**

The AeroNOx 2.0™ has adjustable alarm limits for the NO, O<sub>2</sub>, and NO<sub>2</sub> analysis system, set with the buttons on the front panel. Alarm indications are both audible and visual. The NO alarm is capable of settings between 0 and 99. The NO<sub>2</sub> only has a High alarm limit only up to 9. The oxygen has a low alarm limit of 18 and a high alarm limit of 100.

If the analyzed concentration of gas meets the conditions listed below, the microprocessor will cause the solenoid valves to shut off flow of Nitric Oxide and a High Priority Alarm will be displayed. When conditions return to within the specifications, the valves will sequence and restart the flow.

- NO > 5 ppm above the NO High Alarm setting
- NO > 100 ppm
- NO<sub>2</sub> > 1 ppm above the NO<sub>2</sub> High Alarm setting
- NO<sub>2</sub> > 9 ppm

The following table summarizes the various messages and warnings, which may be displayed by the AeroNOx 2.0™.

High Priority Alarms			
<b>O<sub>2</sub> &lt; 18%</b>			
<b>NO<sub>2</sub> High</b> NO <sub>2</sub> > NO <sub>2</sub> limit + 1 ppm (Alternating)			
<b>NO<sub>2</sub> High</b> NO <sub>2</sub> > NO <sub>2</sub> limit			

Medium Priority Alarms			
<b>NO High</b> NO > NO limit + 5ppm (Alternating)			
<b>NO High</b> NO > NO limit		<b>O<sub>2</sub> High</b>	
<b>Sample line Blocked</b>		<b>O<sub>2</sub> Low</b>	
<b>Power Supply Failure</b> (Alternating)			

Low Priority Alarms			
<b>Low Battery</b>		<b>NO Low</b>	

Other Messages																			
<b>SAFETY OFF</b>																			
<b>SAFETY ON</b>																			
<b>INTERNAL ERROR</b>	<div style="background-color: #ADD8E6; padding: 10px;"> <p style="text-align: center; margin: 0;"><b>INTERNAL ERROR</b></p> <p style="font-size: small; margin: 0;">An internal error has occurred. Please reboot the system and attempt the operation again. If the error persists, please contact International Biomedical for technical support.</p> <p style="margin-top: 10px; font-size: x-small;">ERROR CODE: 0x01</p> </div> <div style="margin-top: 10px;"> <p><b>ERROR CODES LEGEND :</b></p> <table style="font-size: x-small; border: none;"> <tr><td>UNKNOWN</td><td>0x00</td></tr> <tr><td>EZLCD_RET_ERR</td><td>0x01</td></tr> <tr><td>EZLCD_TIMEOUT</td><td>0x02</td></tr> <tr><td>ROM_CORRUPTED</td><td>0x03</td></tr> <tr><td>ROM_WRITE_FAILURE</td><td>0x04</td></tr> <tr><td>STATE_CORRUPTED</td><td>0x05</td></tr> <tr><td>RTI_STOPPED</td><td>0x06</td></tr> <tr><td>WATCHDOG_TIMER</td><td>0x07</td></tr> <tr><td>RX_OVERRUN</td><td>0x08</td></tr> </table> </div>	UNKNOWN	0x00	EZLCD_RET_ERR	0x01	EZLCD_TIMEOUT	0x02	ROM_CORRUPTED	0x03	ROM_WRITE_FAILURE	0x04	STATE_CORRUPTED	0x05	RTI_STOPPED	0x06	WATCHDOG_TIMER	0x07	RX_OVERRUN	0x08
UNKNOWN	0x00																		
EZLCD_RET_ERR	0x01																		
EZLCD_TIMEOUT	0x02																		
ROM_CORRUPTED	0x03																		
ROM_WRITE_FAILURE	0x04																		
STATE_CORRUPTED	0x05																		
RTI_STOPPED	0x06																		
WATCHDOG_TIMER	0x07																		
RX_OVERRUN	0x08																		

### 3.9.6. Safety On/Off

During initial setup with each patient, the user may find situations where safety alarms shutoff the flow of Nitric Oxide before adjustments can be made. To allow for these situations, a Safety Off mode can be enabled by pressing the “Alarm Pause” and “Back” buttons for ~5 seconds. This disables the “Nitric Off” from occurring so adjustments can be made to get the flow concentration stabilized. The device automatically exits “Safety Off” mode after 5 minutes or when restarted. The user can alternatively return to “Safety On” by holding the buttons again. In both cases, a message will appear informing the user of the condition.

**WARNING:**      **Safety features have been disabled for setup or troubleshooting. Do not enter “Safety Off” mode with patient connected.**

### 3.10. Environmental Effects

#### 3.10.1. **Nitric Oxide and Nitrogen Dioxide Sensors**

The Nitric Oxide (NO) and Nitrogen Dioxide (NO<sub>2</sub>) sensors utilized in the AeroNOx 2.0™ are amperometric (also called electrochemical). They can be thought of as micro fuel cells, as they produce a measurable electric current while oxidizing or reducing traces of electroactive gases. The simplest form of sensor operating on electrochemical principles has two electrodes - SENSE and COUNTER - separated by a layer of electrolyte and connected by a low resistance external circuit. Gas diffusing into the sensor is either oxidized or reduced reacted at the surface of the SENSE electrode, causing a current to flow between the electrodes through the external circuit. The current is proportional to the concentration of gas and can be measured across a load resistor in the external circuit.

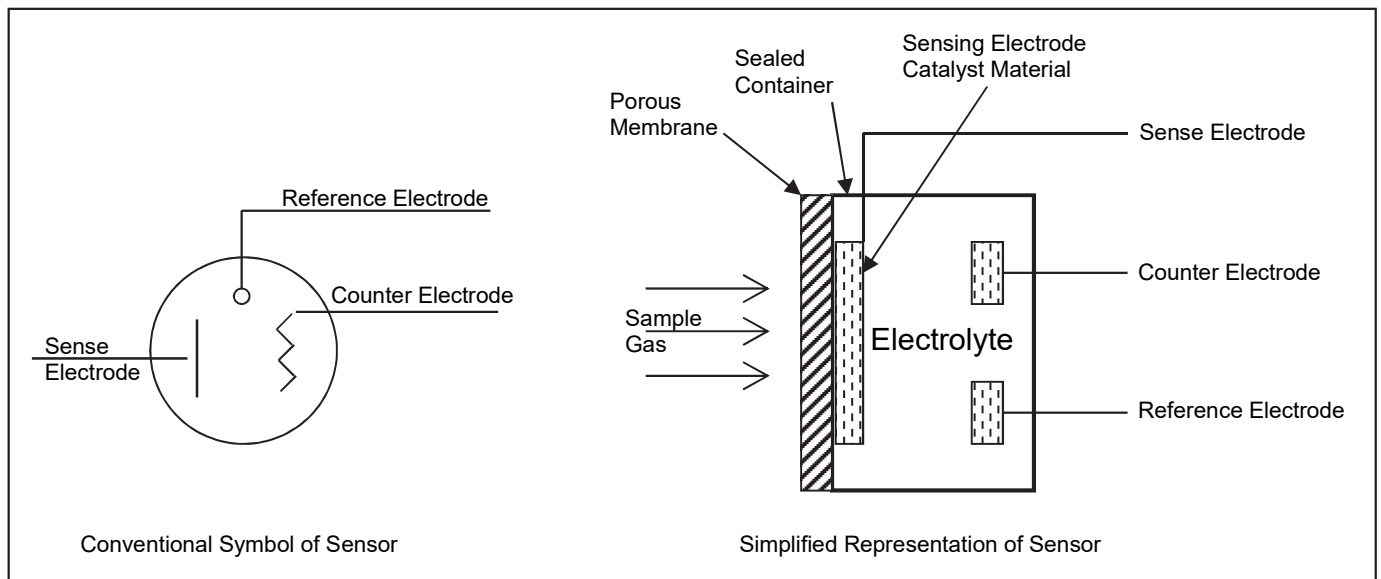

**Figure 1 Schematic and Conventional Representations of Electrochemical Gas Sensor**

For reaction to take place, the SENSE electrode potential must be within a specific range. As the gas concentration increases so does the current flow, causing a change in the potential of the COUNTER electrode (polarization). With the electrodes connected together by a simple load resistor, the SENSE electrode potential follows that of the COUNTER. Using a third REFERENCE electrode and an external potentiostatic operating circuit, the range of concentrations a sensor can be used to measure is much greater. With this arrangement, the SENSE electrode is held at a fixed potential relative to the REFERENCE electrode. No current is drawn from the REFERENCE electrode, so both maintain a constant potential. The COUNTER electrode is still free to polarize, but this has no effect on the SENSE electrode and so does not limit the sensor in any way. By controlling the potential of the SENSE electrode, the potentiostatic circuit also allows greater selectivity and improved response to the target gas. The same circuit is used to measure the current flow between the SENSE and COUNTER electrodes.

Gas diffusing into a cell becomes part of a reaction at the SENSE electrode: oxidation (e.g. Nitric Oxide) or reduction (e.g. nitrogen dioxide). Each reaction can be represented in standard chemical equation form.

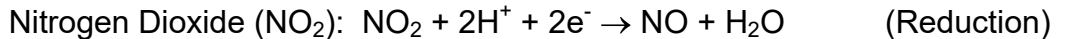

The COUNTER electrode acts to balance out the reaction at the SENSE electrode. If oxidation occurs at the SENSE electrode, oxygen will be reduced to form water at the COUNTER. If, however, the SENSE electrode reaction is a reduction, the COUNTER electrode reaction will be reversed (i.e. water will be oxidized). The standard equation for this electrode can be written as:

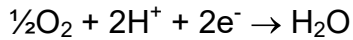

This overall equation demonstrates that the fuel for the reactions is gases supplied to the sensor and the product is a gas emitted. In other words the sensor is merely a catalyst for the reaction, and no part of it is directly consumed.

### 3.10.2. Temperature Effects

A small signal known as the 'baseline' is present on the SENSE electrode of the cell even when no reactant gas is present. The magnitude of the baseline increases exponentially with temperature, but can be 'zeroed' out during calibration. A large temperature change after calibration can cause a slight shifting in an instrument's zero. Even with wide temperature variations, such a shift will normally be too small to be significant. However, if the application requires very high resolution, at very low concentrations, a zero shift could significantly alter the overall measurement. A fourth pin on these electrochemical cells is used to compensate for temperature effects.

### 3.10.3. Nitrogen Dioxide (NO<sub>2</sub>) Analyzer Circuit

The nitrogen dioxide sensor and signal conditioning circuitry is located on the Sensor Board. The signal conditioning circuitry provides cell bias and power off support in addition to converting the cell output current to a voltage. The output voltage includes compensation from the Auxiliary electrode on the electrochemical cell, and is nominally **V(NO<sub>2</sub>) = 250mV/ppm**. The voltage is then sent to the control board where it is sampled by a dedicated Analog to Digital converter and presented to the processor.

To maintain the cell in a ready to work state when an instrument is switched off, the NO cell's REFERENCE, AUXILIARY, and SENSE electrodes are shorted together and the COUNTER electrode is disconnected from the amplifier circuit.

**CAUTION:** While shorted, it is important to avoid exposure to active gases or solvent vapors. Exposure to active gases and solvents in the shorted state will cause damage to the sensor cells.

This emphasizes the importance of "flushing" the sampling system with oxygen or clean air for a few minutes before turning the instrument off after use.

#### 3.10.4. **Nitric Oxide (NO) Analyzer Circuit**

The Nitric Oxide analyzer circuit is similar in design to the NO<sub>2</sub> circuit. The amplifier circuit and standby cell conditioning are different due to the nature of the electrochemical cell. The signal conditioning, cell bias, and output amplifier are contained on the sensor board. The output voltage includes compensation from the Auxiliary electrode on the electrochemical cell, and is nominally **V(NO) = 25mV/ppm**. The output voltage is sent to an additional dedicated Analog to Digital on the control board, controlled and read by the processor.

The NO electrochemical cell requires a 300mV bias between the COUNTER and REFERENCE electrodes at all times. Losing cell bias or installing a new unbiased sensor will produce a large, rapidly decreasing baseline which will require 48 hours to stabilize before stable measurements can be made. The baseline will take about three weeks to fully stabilize. For this reason, the power supplies associated with the sensor circuits are ON anytime the battery is installed.

This emphasizes the importance of keeping the unit plugged into the charger in between uses. Doing so will maintain the unit in a ready to work state.

#### 3.10.5. **NO / NO<sub>2</sub> Circuit Calibration**

For maximum accuracy, cells should be calibrated using a gas mixture in the range where most measurements are to be made or where this is not possible, choose a mixture towards the top of the cell range. Calibration gases exceeding the range of the cell must not be used, as this may not provide an accurate calibration.

As calibration normally involves exposing the sensing face of the cell to gas for a relatively short period, a calibration gas need not contain oxygen - sufficient is supplied from ambient air, for a limited time, through the side access paths. In most cases, a five-minute exposure time is sufficient to achieve a stable calibration signal. Depending on the equipment used, however, NO<sub>2</sub> cells may need a longer exposure time due to surface adsorption.

#### 3.10.6. **Pressure Effects**

Cells will give a transient response when exposed to sudden changes in pressure in the presence of a measured gas; however the peak signal decays in only a few seconds.

#### 3.10.7. **Temperature Dependence**

Both the span signal and the baseline (zero gas current) are affected by temperature. The output from a cell will vary only slightly with temperature. Rapid changes in temperature will create a transient response, which will die away after 20 - 30 seconds. The graphs show the typical variation in span output with temperature for cells calibrated at 20° C to a reading of 100% from a suitable test gas.

### 3.10.8. Humidity Effects

Toxic gas cells use aqueous electrolytes, which, in conjunction with the porous diffusion barrier, permit water vapor to be absorbed into the electrolyte under conditions of high water vapor pressure, and allow the electrolyte to dry out at very low ambient water vapor pressure. Normally, provided conditions are non-condensing, the cell performance is relatively unaffected by humidity. However, some sensors will show a transient response when rapid changes in humidity occur. This should die away after about 20 - 30 seconds.

Continuous operation is possible between 15% and 90% RH over the full operating temperature range without affecting sensor life or performance as, under these conditions, the electrolyte will reach equilibrium with the external water vapor pressure. It is possible to operate outside these conditions, but water transfer may occur and must be taken into consideration.

### 3.10.9. High Humidity, High Temperature

Water will slowly diffuse in under continuous operation at high temperatures and 90 - 100% RH. If water uptake exceeds the free space available, then the sensor becomes prone to leakage - increasingly so as more and more water is taken up by the sensor. Lowering the humidity before leakage occurs will gradually restore the sensor to its original condition and no permanent harm will result from this exposure.

If a sensor is being affected by condensation, drying it with a soft tissue will restore normal operation. Do not heat sensors above 40° C to dry them out.

### 3.10.10. Low Humidity, High Temperature

In continuous operation at 0 - 15% RH, water will diffuse out, only becoming a problem when the volume of electrolyte has decreased by more than 40%. At this point, the gas sensitivity of the sensor will be affected and the housing and seals may be attacked by the very concentrated electrolyte. Exposure to a RH above 15% will begin to restore the water balance, provided a sensor is not left in this condition long enough for a reduction in the electrolyte to take place. A medium sensitivity cell can operate for around six to seven weeks at 100% RH and 40° C (continuous) and two to three weeks at 0% RH (continuous). In general, low sensitivity cells will have slow water transfer rates, whereas high sensitivity cells will have higher water transfer rates, and should be operated for shorter periods of time in these conditions. The cells used in the AeroNOx 2.0™ are towards the higher sensitivity end of the range.

### 3.10.11. Cell Handling

Toxic gas cells have a rugged design and are relatively insensitive to mishandling. Following these few simple guidelines will ensure correct operation in service:

- Do not subject the cells to any pressure when clamping or handling.
- Do not remove or puncture the protective mesh or the underside slipcover over the capillary region.
- The cell contains a small volume of strong mineral acid. *In the unlikely event of a leak, avoid contact with skin, eyes, and clothing. If exposed, rinse contaminated parts thoroughly with water and consult a physician.*



- Do not use solvent based glue directly on or near the cell as the solvent will cause crazing of the plastic and damage to the electrodes can result from high concentrations of solvent vapors.
- Do not store or assemble in areas that contain solvent vapors, including aerosols used in the environment such as air-freshener, wax polish, window cleaner, and all organic solvents. Formaldehyde, for example, is known to temporarily inhibit the operation of Nitric Oxide sensors. Other solvents are known to create false high baselines and, in some cases, may damage the electrodes.
- Sensors in which the PTFE membrane is clearly visible must not be stacked on top of each other as the capillary region is particularly susceptible to damage from Printed Circuit Board pins.
- Do not solder connections directly onto gold Printed Circuit Board pins of a cell.
- Do not bend the pin connections.

Individual data sheets include tables of the cross-sensitivity of each cell to gases other than their target gas. These tables show the typical response of a sensor to a given concentration of test gas, normally around the Threshold Limit Value level. All values were obtained experimentally at City Technology. Depending on the nature of the reaction each gas has with the sensor, the effect can either decrease the signal (negative cross-sensitivity) or increase the signal (positive cross-sensitivity). For safety concerns, a negative cross-sensitivity may present more problems than a positive one, as this will serve to diminish the response to the target gas and so inhibit any alarm. In such cases, it may be necessary to monitor both gases. When a sensor shows cross-sensitivity to a particular gas, whether or not this is a threat to accuracy in an application depends on the degree of accuracy required and the relative concentration of this gas relative to the target gas. For instance where  $\pm 10\%$  accuracy is needed, any gas likely to be present in a high enough concentration to cause a 10% signal should be monitored separately.

### 3.10.12. **Oxygen Sensor**

The oxygen cell used in the AeroNOx 2.0™ is of the self-powered, diffusion limited, metal-air battery type comprised of an anode, an electrolyte and an air cathode as shown below. At the cathode, oxygen is reduced to hydroxyl ions according to the equation:

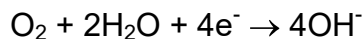

The hydroxyl ions in turn oxidize the metal anode as follows:



Overall the cell reaction may be represented as:

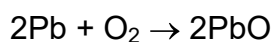

Oxygen cells are current generators, and the current is proportional to the rate of oxygen consumption. This current can be measured by connecting a resistor across the output terminals to produce a voltage signal. If the passage of oxygen into the sensor is purely diffusion limited, this signal is a measure of oxygen concentration.

### 3.10.13. Oxygen Analyzer Circuit

As the O<sub>2</sub> sensor also contains the output resistor, minimal signal conditioning is required. This circuitry is located on the sensor board and provides an output voltage proportional to the % oxygen. This voltage is sent to the control board where it is read directly by the processors internal Analog to Digital Converter. Sensor output drops as the cell ages. Like the NO and NO<sub>2</sub> circuits, O<sub>2</sub> circuit calibration is handled in software and requires no mechanical adjustments by the user.

### 3.10.14. Linearity

The signal from an Oxygen cell is slightly non-linear and follows the law:

$$S = K \ln[1/(1-C)]$$

**NOTE:** *If the sensor is calibrated in dry air to read 20.9% (S=20.9, C=0.209), then K=89.14. The maximum error then occurs at about 10% Oxygen when the cell output is approximately 0.5% lower than a linear response would indicate. In most circumstances this error is insignificant.*

### 3.10.15. Carrier Gas Effects

For most purposes, the Oxygen cell may simply be calibrated in ambient air. In the presence of high concentrations of gases other than air, however, the effect of the carrier gas (i.e. mixture less oxygen) on the output signal becomes important. The rate of diffusion of oxygen, and hence the signal from a cell, is proportional to the molecular weight of the carrier gas (Graham's Law).

Dry air may be considered to consist of 20.95% oxygen in nitrogen, which has a molecular weight of 28 g/mole. When using the sensor with a different carrier gas, with a significantly different molecular weight from nitrogen, the signal from the cell will be affected.

### 3.10.16. Cross Sensitivity

Toxic gases at Threshold Limit Value levels will have no cross-sensitivity effect on the Oxygen cell. At very high levels (i.e. percent levels), highly oxidizing gases (e.g. ozone and chlorine) will interfere to the extent of their oxygen equivalent, but most other commonly occurring gases will have no effect.

For example:

Methane 100%	0
Hydrocarbons 100%	0
Hydrogen 100%	< -2%
Carbon monoxide 20%	< -0.5%

Acid gases such as CO<sub>2</sub> and SO<sub>2</sub> will be slightly absorbed by the electrolyte and tend to increase the flux of oxygen to the electrode. This gives an enhanced oxygen signal of about 0.3% of signal per 1% CO<sub>2</sub>. Oxygen cells are not suitable for continuous operation in concentrations of CO<sub>2</sub> above 25%.

**NOTE:** *Sensors should not be subjected to prolonged exposure to highly corrosive atmospheres as this will cause premature failure.*

### 3.10.17. **Temperature / Pressure Dependence**

The output of an Oxygen cell varies slightly with gradual changes in temperature, but when exposed to a step change in temperature, these sensors exhibit a transient response - a signal decrease for a sharp rise in temperature and a signal increase for a sharp drop in temperature. The temperature transient will diminish in about 20 seconds.

Oxygen cells will give a transient response to step changes in pressure - a signal increase for increased pressure and a signal decrease for decreased pressure. This transient will disappear after about 8 - 10 seconds. Mechanical shock may also cause the sensors to give a temporary increase in signal.

### 3.10.18. **Oxygen Concentration vs. Humidity**

Prolonged periods of operation in either extremely high, or extremely low, relative humidity will have little effect on the sensors. Changes in relative humidity of a gas sample will affect the volume % concentration of oxygen, and therefore the output of a cell due to the dilution effect caused by increasing water vapor pressure. The current given by Oxygen cell is only affected inasmuch as the concentration of oxygen varies.

In conditions where liquid condensation may occur, liquids may form in the region of the gas access hole, which will restrict the flow of gas to the sensor, resulting in a low signal. If a sensor shows signs of being affected by condensation, drying the sensor with a soft tissue may restore normal operation. Under no circumstances should the sensors be heated above 40° C to dry them.

### 3.10.19. **Oxygen Cell Handling Precautions**

Oxygen cells are relatively insensitive to mishandling and following the simple guidelines given below should ensure correct operation.

- Oxygen sensors may be stored for up to six months during which time they should be kept sealed in the containers in which they are supplied in clean dry air at 0 - 20° C.
- Do not store sensors in areas containing solvent vapors, as exposure to organic solvent vapors may inhibit their performance.
- Oxygen sensors must not be subjected to any pressure when handling or clamping.
- At the end of its life, please dispose of the cell properly as it contains a small amount of lead.

### 3.11. Mass Flow Meter Circuit



The mass flow meter (MFM) circuit operates when the unit is powered on. The flowmeter produces a ratiometric analog output voltage of 0.5 V - 4.5 V over the full span of 0-2 L/min. The signal is offset and amplified before being interpreted by the processor's onboard Analog to Digital converter.

## 4. CALIBRATION

The AeroNOx 2.0™ must be zeroed daily and high calibrated at least weekly as part of normal use to ensure the sensors are functioning correctly and the device is operating normally. This calibration is in addition to the yearly preventative maintenance that must be performed to each device. More detail on preventative maintenance can be found in Section 5 of this service manual. The device must have been charged or charging for at least 48 hours to obtain a stable measurement with fully biased sensors. The unit does not have to be “ON”, but the internal battery must have been connected. Even while powered off, the device slowly drains the battery maintaining a sensor bias. After about a week, the internal battery will be dead and the sensors will become unbiased. Recharging will replenish the battery and re-bias the cells.

### 4.1. Low Range Calibration (Daily)

The low range calibration of the AeroNOx 2.0™ uses room air to calibrate the NO, NO<sub>2</sub> and O<sub>2</sub> sensors at the same time. The system draws in room air from the sample port. This must also be done prior to the weekly high calibration.

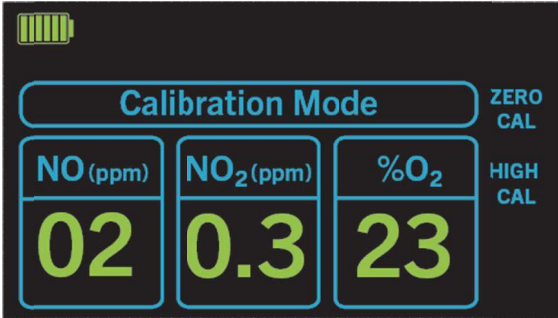
Low Range Calibration	
<p>If unit is on, turn unit off and back on again using power button on front of AeroNOx 2.0™.</p> <p>During startup press and hold the “BACK” soft key to enter calibration mode. It will only be available for ~5 seconds.</p>	
<p>Press “Zero Cal” soft key to enter low range calibration.</p> <p><b>NOTE:</b> “Zero” value for O<sub>2</sub> is 21%.</p> <p>Unplug sample line or calibration circuit if connected. Allow the device to sample ambient air for a few minutes to clear out the sample path.</p>	
<p>Press “Zero Cal” soft key to enter low range calibration.</p> <p><b>NOTE:</b> “Zero” value for O<sub>2</sub> is 21%.</p> <p>Unplug sample line or calibration circuit if connected. Allow the device to sample ambient air for a few minutes to clear out the sample path.</p>	

Press and hold “**Hold to ZERO**” soft key until timer completes (~3 seconds).  
When zero calibration is finished it will read “Done”.

Monitor should indicate:  
NO - 0 ppm  
NO<sub>2</sub> - 0 ppm  
%O<sub>2</sub> – 21%

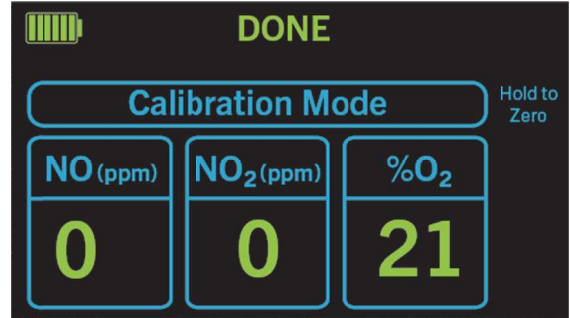
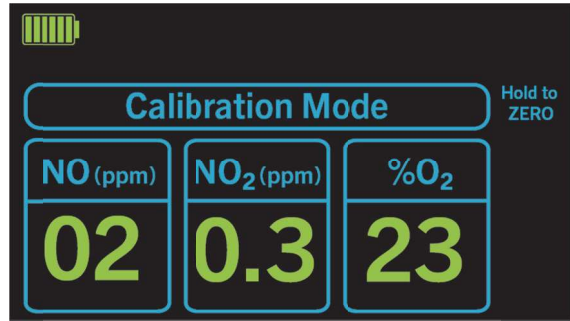

#### 4.2. O<sub>2</sub> High Range Calibration (Weekly)

High range calibration requires a 100% O<sub>2</sub> user supplied gas source. Low Range calibration must be performed first.

### O<sub>2</sub> High Range Calibration

Enter Calibration Mode by holding “**BACK**” button on startup.



Press “**High Cal**” soft key.

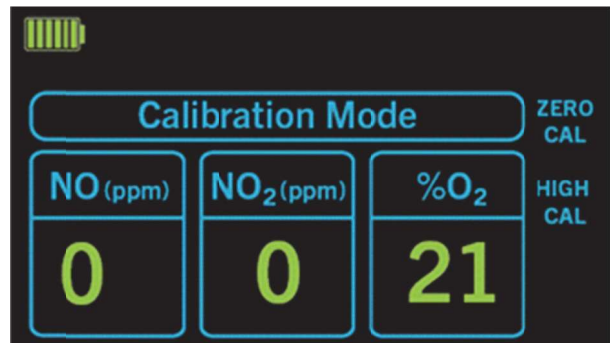

Connect calibration circuit (P/N 738-1850) to 100% O<sub>2</sub> gas source.

Set O<sub>2</sub> to ~1 L/Min.

**NOTE:** Check valve will dump excess flow if oversupply of O<sub>2</sub> is given.

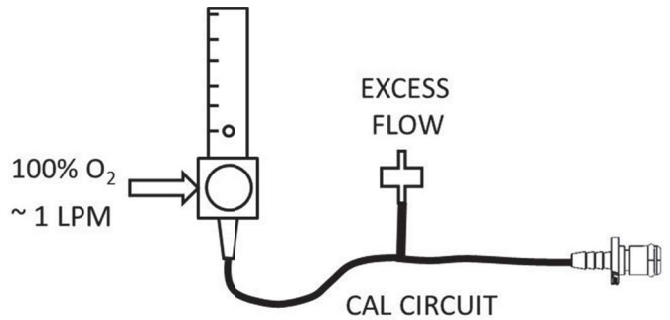

Connect sample line plug of calibration circuit into AeroNOx 2.0™ sample port.

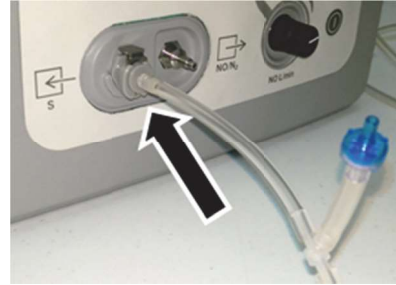

Press “O<sub>2</sub>” soft key.

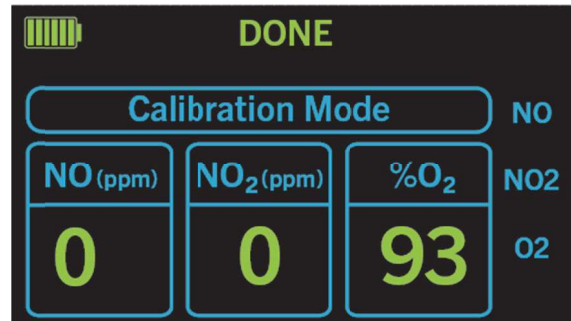

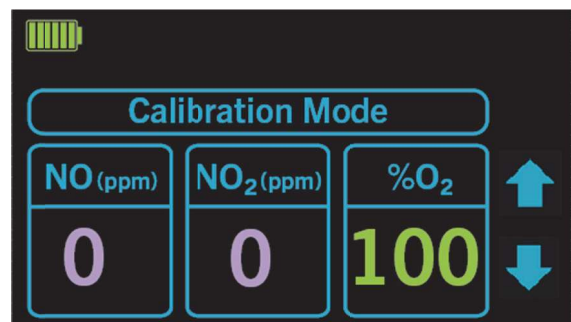

O<sub>2</sub>% becomes highlighted and displays current measured value. When display has stabilized after 2-4 minutes, use “UP AND DOWN” arrow keys to adjust reading to 100% O<sub>2</sub>.

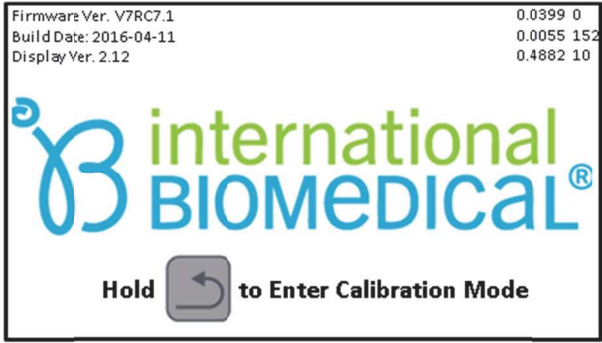

4.3. NO High Range Calibration (Weekly)

Ensure that low range calibration was performed first.

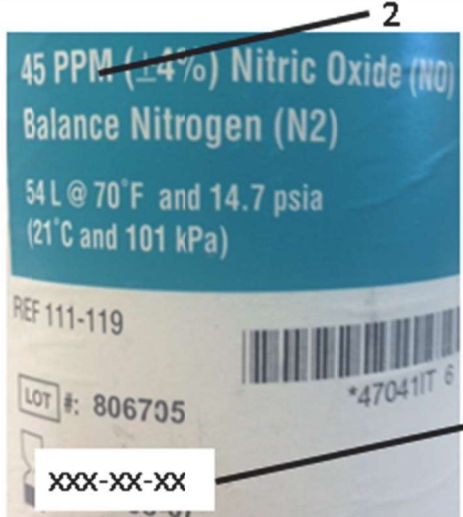
<b>NO High Range Calibration</b>	
<p>If O<sub>2</sub> high calibration was just completed, press the “<b>BACK</b>” button until gas selection screen is shown.</p> <p>Otherwise, enter Calibration Mode by holding “<b>BACK</b>” button on startup.</p>	
<p>Locate calibration circuit 738-1850.</p> <p><b>NOTE:</b> Same calibration circuit from O<sub>2</sub> may be used.</p>	
<p>Obtain NO Calibration gas and calibration regulator, confirm the following from the label:</p> <ol style="list-style-type: none"> <li>1. Expiration Date</li> <li>2. Concentration</li> </ol>	

Connect calibration regulator to NO calibration gas. Connect calibration circuit to calibration regulator.

1. Calibration regulator (731-9141)
2. Calibration Circuit (738-1850)

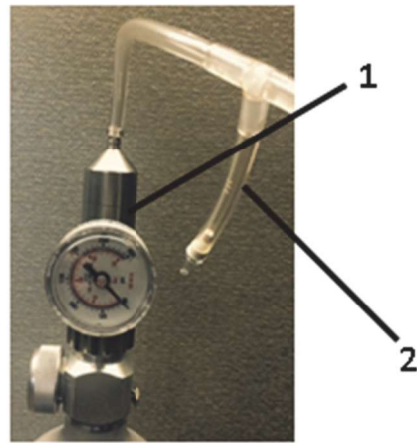

Press “NO” soft key.

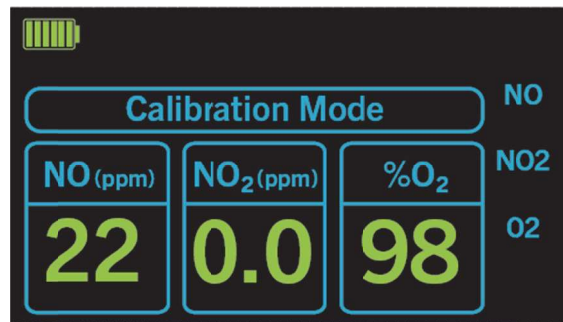

NO ppm becomes highlighted and displays current measured value.

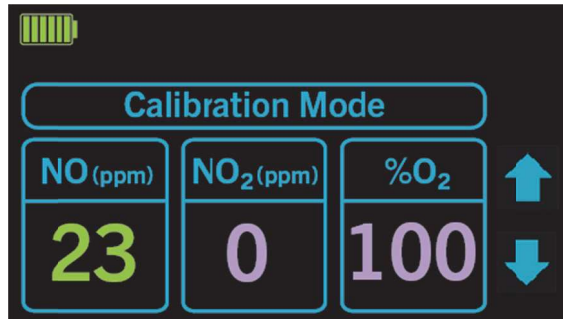

Turn cylinder on. (Replace cylinder if pressure is below 500 psi). Allow gas to vent for 10 seconds then attach calibration circuit to the AeroNOx 2.0™ sample inlet.





When NO display has stabilized after 2-4 minutes, use “**UP AND DOWN**” arrow keys to adjust reading to concentration on label (i.e., 45 ppm).

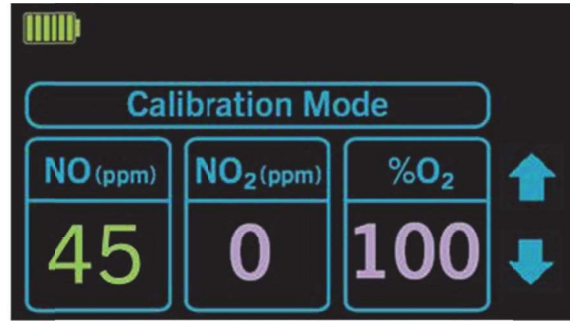

4.4. NO<sub>2</sub> High Range Calibration (Weekly)  
Perform low range calibration first.

**NO<sub>2</sub> High Range Calibration**

If NO high calibration was just completed, press the “**BACK**” button until gas selection screen is shown.  
Otherwise, enter Calibration Mode by holding “**BACK**” button on startup.

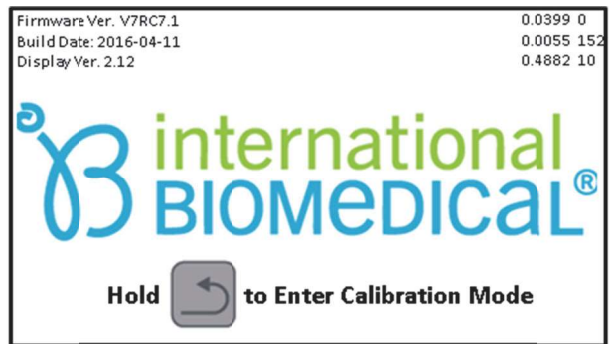

Locate calibration circuit.

**NOTE:** Same calibration circuit from O<sub>2</sub> and NO<sub>2</sub> may be used.



Obtain NO<sub>2</sub> Calibration gas, confirm the following from the label:

1. Expiration Date
2. Concentration

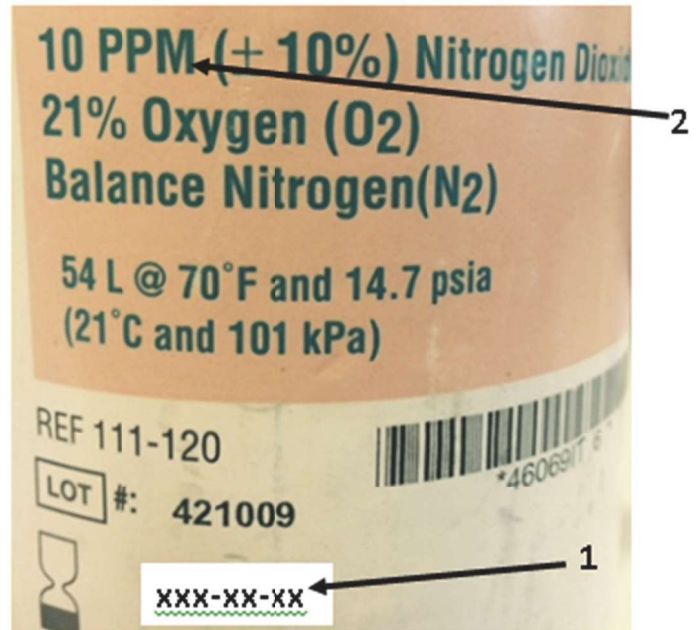

Connect calibration regulator to NO<sub>2</sub> calibration gas. Connect calibration circuit to calibration regulator.

1. Calibration Regulator (731-9141)
2. Calibration Circuit (738-1850)

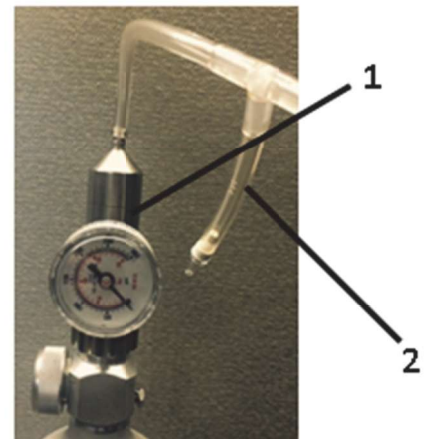

Press "NO<sub>2</sub>" soft key.

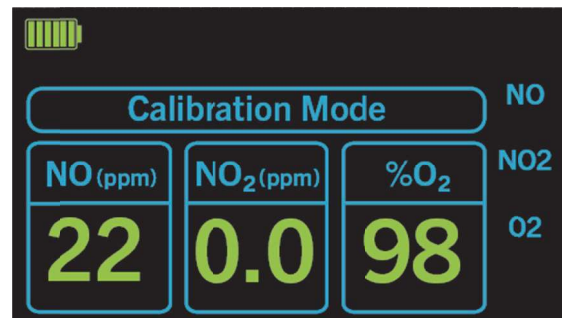

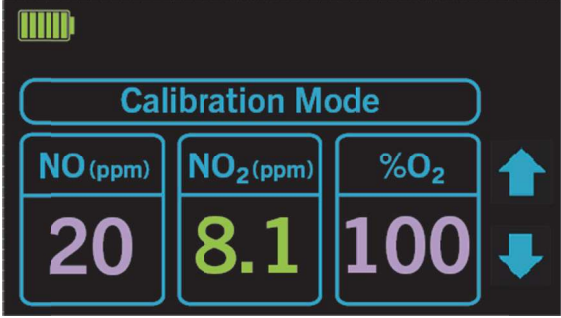
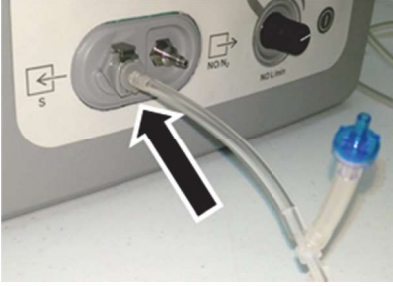
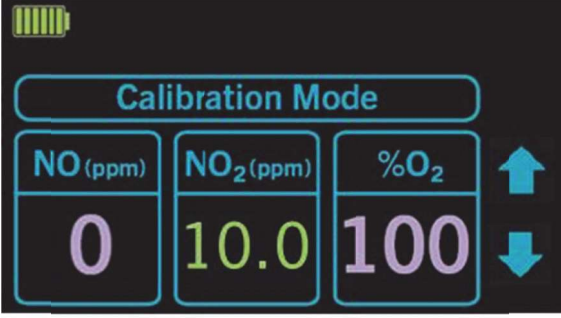
<p>NO<sub>2</sub> ppm becomes highlighted and displays current measured value.</p>	
<p>Turn cylinder on. (Replace cylinder if pressure is below 500 psi). Allow gas to vent for 10 seconds then attach calibration circuit to the AeroNOx 2.0™ sample inlet.</p>	
<p>When NO<sub>2</sub> display has stabilized after 2-4 minutes, use <b>“UP AND DOWN”</b> arrow soft keys to adjust reading to concentration on label (i.e., 10.0 ppm).</p>	

The AeroNOx 2.0™ is calibrated and ready for use.

## 5. MAINTENANCE

### 5.1. AeroNOx 2.0™ Service Procedures Overview

The AeroNOx 2.0™ has a Nitric Oxide (NO) delivery flow path and a Sampling flow path to verify the NO concentration delivered to the ventilator circuit. During assembly, repair, or yearly PM, both paths must be verified to be leak-free and measuring accurately. This must be done in addition to in-use low and high calibration that is performed each day or each week.

The NO delivery path begins with a quick disconnect, then a precision needle valve (Porter valve) meters the flow down to less than 1.0 L/min in most setups. After leaving the Porter valve the flow is measured with a mass flow sensor and directed to the ventilator circuit via two solenoid valves. Due to the high pressure and the nature of Nitric Oxide gas, a leak check is imperative. The mass flow sensor does not require adjustment; however its accuracy is checked in this procedure.

The sampling system pump draws up to 220 mL/min from a port downstream of the delivery injection site on the ventilator circuit. The de-humidified sample enters the AeroNOx 2.0™ via Nafion dryer tubing and a disposable filter connected to a quick disconnect on the front of the device. It passes by a pressure sensor on the way to the pump before passing over the O<sub>2</sub>, NO, and NO<sub>2</sub> sensors. The pressure sensor triggers an alarm if the sample line is blocked, creating a vacuum pressure less than 50 millibars. The sample exits the rear of the device via a filtered exhaust port. The pump voltage and pressure sensor trip point may be adjusted to compensate for component tolerances and wear via two potentiometers inside the device. During assembly or service, the sample circuit may be calibrated and checked without sensors present. However, to perform gas testing and sensor calibration, the sensors must be installed. It is also recommended the enclosure be closed so any tube or cable routing problems will be found.

This set of procedures is separated into three sections so the appropriate tests may be applied depending on the state of the AeroNOx 2.0™ device under test. Portions of the procedure where disassembly is required for adjustment may be skipped if the device can be tested and verified to be within limits. Any time the case is opened, all three of these procedures should be performed.

## 5.2. Maintenance Tools

DESCRIPTION	SPECIFICATIONS	USAGE	EXAMPLE
Phillips Screwdriver	#1, #2 tips	assembly / disassembly	Xcelite X101 Xcelite X102
HEX Wrenches	2.5 mm, 5 mm, 0 .035"	assembly / disassembly	
Diagonal Cutters		component removal / replacement	Weller 170-M Xcelite 54CG
Needle Nose Pliers		component removal / replacement	Xcelite 57CG
Socket or Nut Driver	5/16", 3/8", 7/16", 1/2"	assembly / disassembly	Xcelite HS8 Xcelite HS10 Xcelite HS12
Digital Multimeter		test and measure	Fluke 73
Miscellaneous Hand Tools as Deemed Appropriate			
ESD Safe Work Surface and ESD Wrist Strap			
52-Pin PLCC Extraction Tool		disassembly	OK EX5
Trimmer Adjustment Tool		adjustments	Spectrol Type 8T000 Bourns Type H91
Water Manometer	80 cmH <sub>2</sub> O	adjustments	Fabricate as required
Gas Flowmeter w/Precision Valve	0 - 250 cc/min	adjustments	
AeroNOx 2.0™ Calibration Circuit		Calibration	738-1850
Gases - NO, NO <sub>2</sub> , O <sub>2</sub> , N <sub>2</sub>		Calibration	
Delivery Line and Regulator		Calibration	738-1853, 731-9141

## 5.3. Scheduled Maintenance

Frequency	Maintenance
Daily	Perform low range calibration (zero).
Start of each patient	Perform pre-use check.
Between each patient	1. Disinfect unit. 2. Ensure unit is plugged into AC power. 3. Replace single use items.
Weekly	Perform high range calibration
Annually	Preventive Maintenance

#### 5.4. Cleaning the AeroNOx 2.0™



1. Disconnect external power before cleaning.
2. Apply cleaning solution to a cloth and wipe down outer surface and cable.
3. Use only the following cleaning agents.
4. Allow unit to dry thoroughly before use. Immediate use after exposure to excessive cleaning agents such as Isopropyl Alcohol can affect sensor performance. Take particular care around the sample inlet.

Cleaning Agent	Active Ingredients
Soap/Water (Various)	Phenols Phospholipid surfactant
Cavicide or Cavi Wipes	Diisobutylphenoxyethoxethyl dimethyl benzyl ammonium chloride 0.07% Isopropyl alcohol 17.2% Inert ingredients 82.5%
Isopropyl Alcohol	Up to 100% Isopropyl Alcohol
Ethanol	Up to 100% Ethanol
Bacillol 30 or Bacillol 30 Wipes	Ethanol Propan-2-ol Propan-1-ol n-alkyl-aminopropyl-glycine
<b><i>NOTE:</i></b> Only applicable to International/EU Markets.	

#### 5.5. Preventive Maintenance



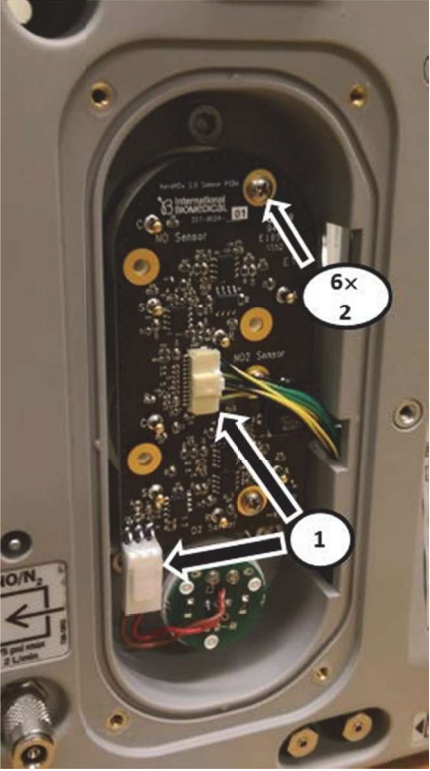

Schedule	Maintenance Interval
Description	Maintenance Interval
NO, NO <sub>2</sub> , and O <sub>2</sub> sensor replacement	1 Year
Calibration of sample flow rate	1 Year
Calibration of NO delivery flow rate	1 Year
Battery replacement	1 Year (888-0115) 2 Years (888-0013)
Inspection of Exterior	1 Year
Inspection of Power Input Connection	1 Year

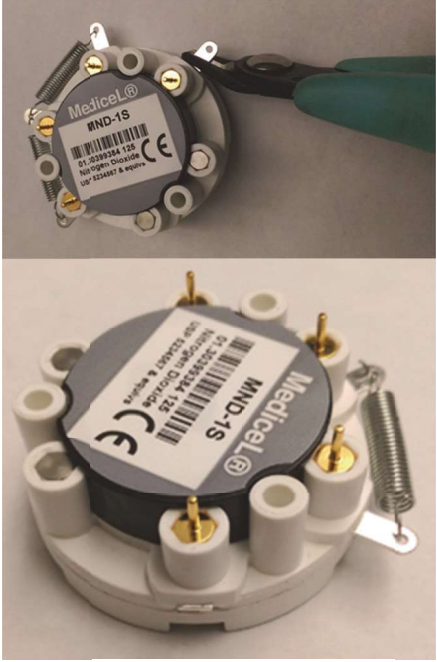
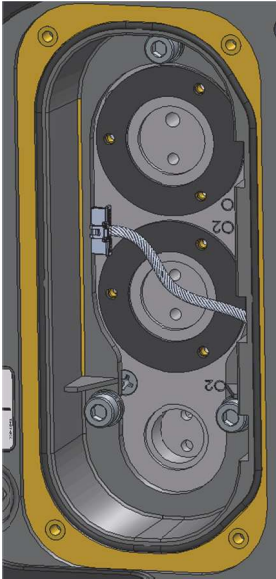
5.6. Replacing NO, NO<sub>2</sub> and O<sub>2</sub> Sensors

Sensor Replacement		
Description	Step	Illustration
<p><b><u>CAUTION:</u> DISCONNECT BATTERY AND EXTERNAL POWER BEFORE SERVICE</b></p>  <p>Remove rear sensor cover by loosening the 4 screws</p>	<p>1</p>	
<ol style="list-style-type: none"> <li>1. Remove both connectors.</li> <li>2. Remove six screws retaining circuit board.</li> <li>3. Lift circuit board out and remove sensors. Note that sensors are socketed to the circuit board but may stick to manifold and/or gaskets. Keep both gaskets for re-use.</li> <li>4. O<sub>2</sub> sensor is removed by unscrewing body counterclockwise. Be careful not to cross thread.</li> </ol>	<p>2</p>	

<ol style="list-style-type: none"> <li>1. Remove the new sensors from their packaging and remove shorting springs, wires, or bias board from sensor if present.</li> <li>2. Carefully clip tabs from sides of sensors to flush with sensor body.</li> </ol> <p>DO NOT CLIP VERTICAL PINS</p>	<p>3</p>	
<p>Re-use gaskets for NO and NO<sub>2</sub> sensors.</p> <p>Use new O-ring supplied with O<sub>2</sub> sensor (already attached).</p>	<p>4</p>	



<p>Install new sensors in reverse order of removal. Be sure NO and NO<sub>2</sub> sensors are placed in their respective locations. They have the same physical pin configuration but are NOT interchangeable.</p>	<p>5</p>	
<p>Replace sensor housing and tighten screws.</p>	<p>6</p>	
<p>Reconnect battery, connect external power supply, and wait 48 hours for new sensors to bias themselves. Then proceed to Calibration, Section 4. Both Low and High Calibration must be performed.</p>	<p>7</p>	 <p>Firmware Ver. V7RC7.1 0.0399 0  Build Date: 2016-04-11 0.0055 152  Display Ver. 2.12 0.4882 10</p> <p><b>international BIOMEDICAL®</b></p> <p>Hold  to Enter Calibration Mode</p>

### 5.7. SLA Battery Replacement



- Replace SLA battery at least every year.
- **Rationale:**
  - Cycle life vs. depth of discharge (Battery datasheet)
  - 200 cycles for 100% discharge (66.7 full discharge events per year)
  - 450 cycles for 50% discharge (150 discharge events per year)
  - 1200 cycles for 30% discharge (400 discharge events per year)
  - Potential for decreased length of discharge cycle, noticed at a time of increased vulnerability (i.e. on internal or external transports)

### 5.8. LiFePO<sub>4</sub> Battery Replacement

- Replace LiFePO<sub>4</sub> battery every 2 years.
- **Rationale:**
  - 1500 cycles for 100% discharge (66.7 full discharge events per year)
  - Potential for decreased length of discharge cycle, noticed at a time of increased vulnerability (i.e. on internal or external transports)
  - Potential for decreased length of discharge cycle, noticed at a time of increased vulnerability (i.e. on internal or external transports)

#### **PLEASE NOTE:**

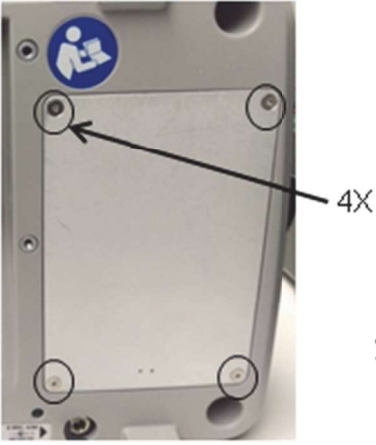
- When the AeroNOx 2.0™ is being used for NO therapy as intended, it is critical that the AeroNOx 2.0™ always be operated with a fully charged functional battery. With a discharged battery, the AeroNOx 2.0™ may continue to operate from the external power supply, but ANY interruption (e.g. intentional or unintentional disconnection of the external power supply) may shut down the device unexpectedly. Electrochemical NO and NO<sub>2</sub> sensors in the machine require a stable voltage source to maintain their bias and give accurate readings. This stable voltage source is the battery supplied with the AeroNOx 2.0™.
- If an SLA battery is deeply discharged, its operating life will be significantly shortened. The LiFePO<sub>4</sub> battery is more tolerant of deep discharges but running it to depletion is discouraged for patient safety. If batteries are left in a discharged state for any period of time, they may become damaged making them incapable of accepting and holding a charge even when they are again connected to the charger supplied with the AeroNOx 2.0™. A fully charged **NEW** 6 VDC 4.5 Ah Battery is capable of operating the AeroNOx 2.0™ reliably for up to 5 hours. This time will decrease as the battery ages and particularly if the battery has been allowed to discharge as explained above. The battery has additional protection built-in to cut-off at a certain voltage to protect the battery from over-discharge.

Description	Illustration
<p>The AeroNOx 2.0™ is shipped with an uninstalled rechargeable battery. <b>To function properly, the device must have the battery installed.</b></p> <p>The batteries are <b>NOT</b> interchangeable.</p> <p>The battery does not require maintenance by anyone other than service personnel according to the maintenance schedule.</p> <p>To install battery, remove four M3 screws securing battery compartment panel.</p>	
<p>Connect the loose battery cable connection in the battery compartment. Tuck mated connection into space next to battery.</p> <p>Replace cover.</p> <p>Reverse operations to remove battery.</p>	
<p>When operating on internal battery power, a battery icon is located on the screen.</p> <p>A fully charged battery will normally run the AeroNOx 2.0™ for five (5) hours in optimal conditions.</p>	

## 5.9. AeroNOx 2.0™ MFM Flow Check/Leak Test Procedure

This document contains detailed instructions for checking the MFM (mass flow meter) flow and for ensuring that there are no leaks in the delivery circuit plumbing or around the stainless steel fittings in an AeroNOx 2.0™. Nitrogen is used as a test flow gas. This procedure is to be performed as part of the AeroNOx 2.0™ production process prior to initial release of the product, at least once annually for units returning from the field, and as part of every servicing process because:

- MFM zero may drift with device age.
- Leaks may be introduced inadvertently by sharp jarring of the device.
- Leaks may be introduced inadvertently during servicing of the gas delivery circuit.
- Leaks may develop due to embrittlement of tubing or stressed connections.

This procedure may be performed on an AeroNOx 2.0™ with or without sensors. The device must have a battery connected to function properly, even with external power applied to the DC jack.

### 5.9.1. **Tools and Materials**

- ESD-protected workstation and grounded wrist strap
- 4 mm hex wrench
- 738-1930 Power Supply, Medical Grade, 40 W, 9 V (for 731-9159 units)
- 738-1964 Power Supply, Medical Grade, 40 W, 9 V, Locking (for 731-0426 units)
- 888-0115 Battery Assembly, SLA, 6 V, 4.5 Ah
- 888-0013 Battery Assembly, LiFePO<sub>4</sub>, 6.4 V, 4.5 Ah
- Potentiometer adjusting tool (e.g. P/N 416-0010 - Calibration Screwdriver, Single)
- 738-1845 Coupling Body, 1/8" Barb
- 374-1630 Tubing, Tygon, 1/8 B. × 1/16 W. × 1/4 OD approximately 3 feet
- Braided stainless steel hose with Swagelok QC4 male quick connect fitting and Beswick miniature quick disconnect (e.g. P/N 738-1862 - AeroNOx 2.0 NO™ Supply Hose, 6'). Use of an adapter to an existing benchtop setup is acceptable.
- Compressed nitrogen delivery gas cylinder with regulator, high side pressure gauge, and low side pressure gauge capable of measuring 30-70 psi, shut-off valve, and female Swagelok quick connect fitting (P/N 278-1002 - Quick Connect, Female, 1/8" Bulkhead).
- Flow meter with range 0 to ≥ 2.0 L/min (e.g. Omega FMA1816A-ST)

## 5.9.2. Leak Check

- 5.9.2.1. **Record** the serial number of the device, flowmeter tool ID#, and Calibration Due date on the Test Record.
- 5.9.2.2. Skip disassembly steps if running a leak check on a completed unit. Remove protective cover and use a 4 mm hex wrench to remove five fasteners holding the case together.
- 5.9.2.3. Separate the halves carefully and support upright on the benchtop. Cables and tubes route from front to back across the bottom edge.
- 5.9.2.4. Attach regulator and/or pressure gauge, shut-off, and female quick disconnect to Nitrogen bottle per figure below. Adapters may be required depending on pressure gauge used.

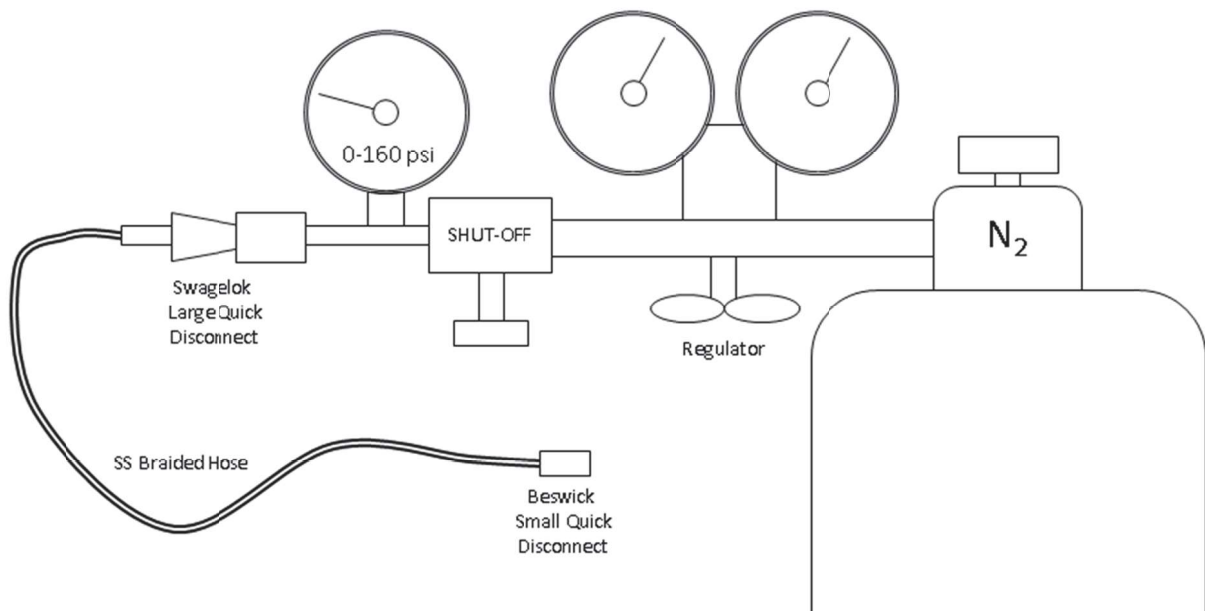

- 5.9.2.5. Attach Stainless Steel hose. Do NOT connect the AeroNOx 2.0™ yet.
- 5.9.2.6. Open regulator (counter clockwise) completely, then open the valve on the Nitrogen bottle. Observe that the high pressure gauge spikes to bottle pressure, and that the low pressure gauge is reading low or zero.
- 5.9.2.7. Slowly close the regulator (clockwise) until the pressure on the low pressure gauge is  $30 \pm 5$  psi.
- 5.9.2.8. The purge pin above the NO/N<sub>2</sub> inlet on the back of the AeroNOx 2.0™ may be used to bleed excess line pressure as required.
- 5.9.2.9. Close the shut-off valve.
- 5.9.2.10. Observe the low pressure gauge for 1 minute. If pressure decreases visibly, check the SS delivery hose and fittings for a leak. Continue if no leak, or repair leak and repeat test until no leak observed.
- 5.9.2.11. The delivery hose is now confirmed to be leak free.
- 5.9.2.12. Open the shut-off valve again and ensure pressure is still  $30 \pm 5$  psi in the hose.

- 5.9.2.13. Open the AeroNOx 2.0™ flow control knob fully (CCW). If already fully opened, do not force it further. Knob may turn 10+ times.
- 5.9.2.14. Connect Beswick (small quick disconnect) to AeroNOx 2.0™.
- 5.9.2.15. Turn on the AeroNOx 2.0™. Hold down the Alarm Silence and Back buttons simultaneously for ~5 seconds to enter "Safety Off" mode". This disables alarms and protections to allow for diagnostics to be performed. If the battery is not installed, use the external 9 VDC supply.
- 5.9.2.16. Connect the delivery fitting and length of Tygon tubing to the output fitting.
- 5.9.2.17. Verify flow is present.
- 5.9.2.18. Block the externally attached delivery tube. Note the delivery line connection may pop off the fitting if the pressure is too high.
- 5.9.2.19. Close the shut-off valve.
- 5.9.2.20. Observe the low pressure gauge for 1 minute. If pressure decreases visibly, check the AeroNOx 2.0™ for a leak. Repair leak if detected and repeat test until no leak observed.
- 5.9.2.21. The delivery side of the AeroNOx 2.0™ is confirmed to be leak free. **Check box on test record.**
- 5.9.2.22. Unblock the delivery tube. Verify that gas is flowing and that the AeroNOx 2.0™ displays NO (L/min)  $\geq 2.00$  L/min. **Check box on test record.**
- 5.9.2.23. Attach the delivery line to the external flowmeter. Note that the actual flow should be much higher than 2.00 L/min due to the Porter valve being fully opened, but the AeroNOx 2.0™ only displays accurately up to 2.0 L/min. The external flowmeter should measure higher if it is capable of a higher range.
- 5.9.2.24. Close the AeroNOx 2.0™ flow control knob partially (CW) until external flowmeter reads 2.00 L/min. **Record values** on test record table.
- 5.9.2.25. Repeat measurements for nominal flow settings in table. **Record values.**
- 5.9.2.26. Close the AeroNOx 2.0™ flow control knob completely (CW) until external flowmeter reads  $\leq 0.01$  L/min.
- 5.9.2.27. Submerge the free end of the Tygon tubing in a cup of water and make sure there is no flow (bubbles). Verify the display NO (L/min) reads  $\leq 0.01$  L/min then **check box on test record.**
- 5.9.2.28. Leak check completed and mass flow sensor check complete. **Check box on test record, Sign and Date.**
- 5.9.2.29. Perform the Sample Rate Adjustment Procedure before closing the case if already opened.

**AeroNOx 2.0™ MFM Flow Check / Leak Test Record for  
AeroNOx 2.0™ S/N \_\_\_\_\_**

1. Record the tool control number and calibration date for the following:

Flowmeter Tool # \_\_\_\_\_ Cal. Due Date \_\_\_\_\_

2. AeroNOx 2.0™ has passed leak testing as specified.  Yes  No

3. No flow and display reads  $\geq 2.00$  L/min at fully open.  Yes  No

4. Record MFM flow check / calibration data in the chart below:

Desired AeroNOx 2.0™ flow Setting (L/min)	External Flowmeter Reading (L/min)	Calculated Difference (L/min)	Max Difference Magnitude Allowed (L/min)
2.00			.10
1.00			.10
0.50			.10
0.20			.10
0			.01

5. No flow (bubbles) observed and NO (L/min)  $\leq 0.01$ .  Yes  No

6. MFM flow is now within the specified parameters at all required nominal flow settings.  Yes  No

**Completed by:** \_\_\_\_\_ (signature of technician)

**Date:** \_\_\_\_\_

## 5.10. AeroNOx 2.0™ Sample Rate Adjustment Procedure

This document provides instructions for adjusting sample flow and the “Sample Blocked” trip point for AeroNOx 2.0™ devices. This procedure is to be performed for all production units prior to their initial release, yearly for units returning from the field, and as part of every servicing process. Changes in sample flow rate are difficult to detect with normal device usage and a low sampling rate may cause slow or unstable sensor readings. This procedure may be performed on an AeroNOx 2.0™ with or without sensors. The device must have a battery connected to function properly, even with external power applied to the DC jack. If a unit under test passes, it does not have to be disassembled and adjusted.

### 5.10.1. **Tools and Materials**

- ESD-protected workstation and grounded wrist strap
- 738-1853 AeroNOx 2.0™ Sample/Delivery Kit
- 738-1930 Power Supply, Medical Grade, 40 W, 9 V, (731-9159 units)
- 738-1964 Power Supply, Medical Grade, 40 W, 9 V, Locking (731-0426 units)
- 300 mm - 0 - 300 mm water column manometer or equivalent pressure meter capable of measuring 60 cm H<sub>2</sub>O or 5900 Pa
- Gas flowmeter setup with precision metering valve
- 416-0010 Calibration Screwdriver, Single
- 4 mm hex wrench
- Multi-meter with leads

### 5.10.2. **Instructions**

**NOTE:** *All flow measurements are assumed to be at standard atmospheric conditions (STP).*

5.10.2.1. Connect power supply to the AeroNOx 2.0™ under test, power the AeroNOx 2.0™ on, and allow the unit to run at least 1 minute before attempting to set sample flow as described below.

5.10.2.2. Set up the flowmeter and precision metering valve as shown. Ensure that both the flow meter and precision metering valves are fully open (fully counterclockwise) to allow unrestricted flow, and adjust the “zero” on the paper marker to the H<sub>2</sub>O level in the water column.

5.10.2.3. Connect the sample line to the AeroNOx 2.0™ sample line inlet.



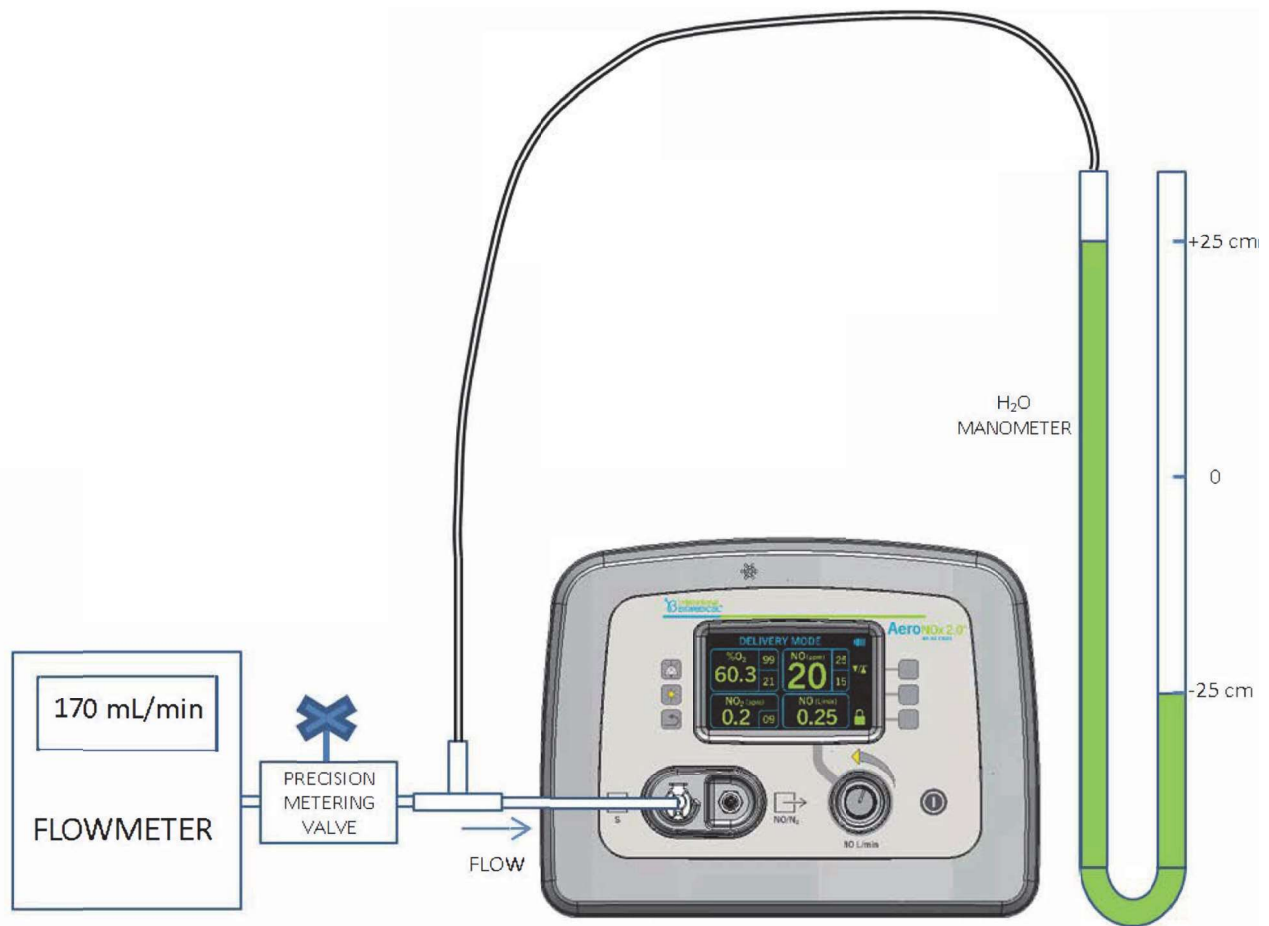

### Flowmeter with Precision Metering Valve and Manometer

**NOTE:** An alternative pressure meter may be used instead of a water manometer.

- 5.10.2.4. Connect the other end to the precision metering valve fitting as shown and power the AeroNOx 2.0™ on.
- 5.10.2.5. Measure the “AS FOUND” flow under no load with the gas flow meter and **Record** this reading in the attached record. The flow rate at no load must be at least 120 mL/min and should be no greater than 220 mL/min.
- 5.10.2.6. Adjust the precision metering valve on the test equipment until the water column in the manometer rises to -50 cm ( $\pm 3$  cm), at which point the pump should shut off. Back the precision metering valve off, and power the AeroNOx 2.0™ off and then back on again to reset the pump. Then, repeat this step one more time to determine whether the flow rate under load as measured by the test equipment is within the specified parameters, namely that when the pump shuts off at -50 cm ( $\pm 3$  cm) H<sub>2</sub>O, the measured flow is at least 120 mL/min and no greater than 220 mL/min). **Record** the “as found” pump shut off point and the flow under load in the attached record.
- 5.10.2.7. If sample flow rate was still within the specified parameters, no further adjustments are required. **Sign and date** the “AeroNOx 2.0™ Sample Rate Adjustment Record”.

5.10.2.8. If sample flow rate adjustment is required, proceed as follows.

**CAUTION:** Perform this procedure in accordance with ESD Control.

5.10.2.9. Power the AeroNOx 2.0™ off, disconnect the power supply, and remove the five M5 screws that hold the AeroNOx 2.0™ case together (4 mm hex wrench). Open the unit, being careful not to unplug connectors.

5.10.2.10. Plug the supply back in and power on the AeroNOx 2.0™. Connect sample line to test fixture if not already connected.

5.10.2.11. As a starting point, adjust R5 so TP\_REF = 0.95 VDC with respect to TP\_SNSGND.

5.10.2.12. As a starting point, adjust R4 until TP\_VPUMP = 1.8 VDC with respect to TP\_SNSGND.

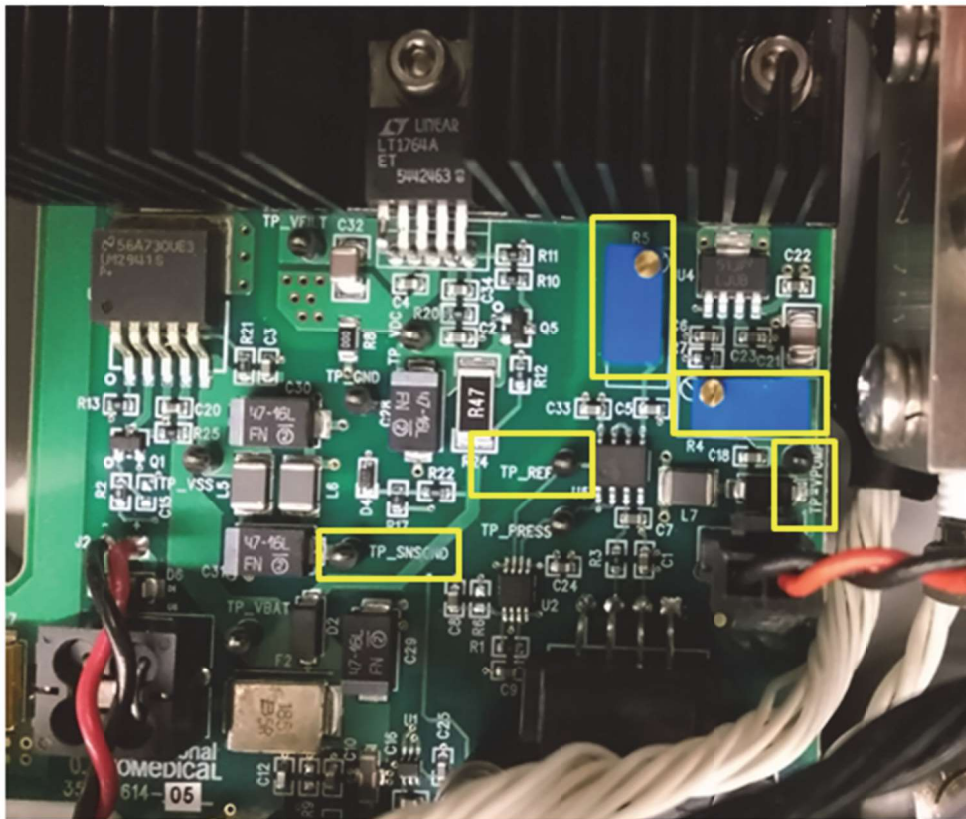

5.10.2.13. Fully open the precision metering valve (CCW) on the test fixture and observe the max flow rate.

5.10.2.14. Adjust R4 until max flow rate is 190 mL/min.

5.10.2.15. Partially close precision metering valve until pressure reaches -52 cmH<sub>2</sub>O.

5.10.2.16. Adjust R5 until pump cuts off.

5.10.2.17. Open precision metering valve all the way and cycle power to clear "Sample Blocked" alarm.

5.10.2.18. Verify max sample flow is still between 130 mL/min and 210 mL/min.

**Record Value.**

- 5.10.2.19. Partially close precision metering valve and verify flow rate at  $-50 \pm 2$  cmH<sub>2</sub>O when pump shuts off is 130 mL/min and 210 mL/min. **Record Value.**
- 5.10.2.20. **Record** check mark if “SAMPLE BLOCKED” visual and audible alarms occur.
- 5.10.2.21. **Record** results of procedure Pass/Fail and why. Repeat adjustment procedure if necessary.
- 5.10.2.22. If the AeroNOx 2.0™ is open due to adjustment or diagnostics, reassemble it. If servicing a complete device, reinstall the protective cover.

**AeroNOx 2.0™ Sample Rate Adjustment Record for  
AeroNOx 2.0™ S/N \_\_\_\_\_**

**Record the equipment identification number and the calibration due date (if applicable) for the following:**

Gas Flowmeter: ID # \_\_\_\_\_ Cal. Due Date \_\_\_\_\_

Multimeter: ID # \_\_\_\_\_ Cal. Due Date \_\_\_\_\_

**AS FOUND Sample Flow Rate Data:**

**N/A Initial calibration needs to be performed.**

1. Flow rate at no load is \_\_\_\_\_. [specification: 120 to 220 mL/min]
2. Pressure at no load is \_\_\_\_\_. [specification: ≤ 4 cmH<sub>2</sub>O]
3. Pump shuts off at \_\_\_\_\_. [specification: -50 ± 3 cmH<sub>2</sub>O]
4. Flow rate at -50 cmH<sub>2</sub>O was \_\_\_\_\_. [specification: 120 to 220 mL/min]

**Pass. Sample rate does NOT require adjustment.**

**Fail. Sample rate needs to be adjusted as specified.**

**ADJUSTED Sample Rate Flow Data:**

1. Flow rate at no load is \_\_\_\_\_. [specification: 130 to 210 mL/min]
2. Pressure at no load is \_\_\_\_\_. [specification: ≤ 4 cmH<sub>2</sub>O]
3. Pump shuts off at \_\_\_\_\_. [specification: -50 ± 2 cmH<sub>2</sub>O]
4. Flow rate at -50 cm H<sub>2</sub>O was \_\_\_\_\_. [specification: 130 to 210 mL/min]

"SAMPLE BLOCKED" functioning and alarms working.

**PASS/FAIL**

**Pass.** Sample rate has been adjusted as specified.

**Fail.** Sample rate could not be adjusted as specified. Recommend:

Pump replacement

Fixed orifice replacement

Other (e.g. pressure sensor replacement) \_\_\_\_\_

**Signature:** \_\_\_\_\_ **Date:** \_\_\_\_\_

## 5.11. AeroNOx 2.0™ Gas Testing Procedure

This document contains detailed instructions for performing the gas test on the AeroNOx 2.0™ with sensors. The device must have a battery connected to function properly, even with external power applied to the DC jack. This procedure applies to all AeroNOx 2.0™ units manufactured by International Biomedical and is to be performed as part of the AeroNOx 2.0™ production process or as part of the servicing process. Leak check and sample rate adjustment procedures must be completed first.

### 5.11.1. **Tools and Materials**

- 738-1850 AeroNOx2, Calibration Circuit  
5 ×, one dedicated to each: O<sub>2</sub>, 80 ppm NO, 45 ppm NO, 9 ppm NO<sub>2</sub>, and 5 ppm NO<sub>2</sub> use
- 731-9141 Calibration Regulator with CGA 625 Fitting  
4 ×, one dedicated for each: 80 ppm NO, 45 ppm NO, 9 ppm NO<sub>2</sub>, and 5 ppm NO<sub>2</sub> use
- 201-0055 Female CGA 660 to Male CGA 625 Adapter  
4 ×, one dedicated for each: 80 ppm NO, 45 ppm NO, 9 ppm NO<sub>2</sub>, and 5 ppm NO<sub>2</sub> use
- Compressed Oxygen Cylinder and regulator with 1240 DISS output
- 731-9130 Flowmeter, Oxygen - Classic 0-16 (or equivalent)
- 731-0127 Hose Assy, Oxy, 6', Supply (or equivalent)

### 5.11.2. **General Instructions**

5.11.2.1. If at any point during the testing procedure the AeroNOx 2.0™ is unable to meet the testing specifications, remove the AeroNOx 2.0™ from testing and contact International Biomedical.

5.11.2.2. Ensure that the AeroNOx 2.0™ to be tested:

- Has been plugged in with the battery connected for at least 48 hours prior to being gas tested.

**NOTE:** *This time can be reduced if the NO sensor has been biased correctly for at least 48 hours.*

- Is turned on and has been running for at least 5 minutes before testing, sampling ambient room air
- Has successfully completed the AeroNOx 2.0™ MFM Flow Check/Plumbing Leak Test Procedure and the AeroNOx 2.0™ Sample Rate Adjustment Procedure

**Record** confirmation of other procedure's completion and attach.

### 5.11.3. **Battery / Charge Indicator Check**

- 5.11.3.1. Ensure that the battery symbol is full when external power is temporarily unplugged. Record this by placing a checkmark in the corresponding box on the AeroNOx 2.0™ Gas Testing Record Form.
- 5.11.3.2. Ensure that the charge symbol is displayed, green LED lights up on front and on back when connected to the 9 V power supply specified for use with the AeroNOx 2.0™. **Record this by placing a checkmark in the corresponding box on the AeroNOx 2.0™ Gas Testing Record Form.**

### 5.11.4. **Zero Calibration**

- 5.11.4.1. Allow the AeroNOx 2.0™ to sample room air for at least 2 minutes. Cycle power, then hold down the “Back” button to enter calibration. Press “zero cal”, then press it again to “hold to zero”. O<sub>2</sub> should now read 21%. NO and NO<sub>2</sub> are zeroed. **Record this by placing checkmarks in the corresponding boxes on the AeroNOx 2.0™ Gas Testing Record Form.**

### 5.11.5. **Oxygen Analyzer Calibration**

- 5.11.5.1. Connect the 731-0127 (or equivalent) Oxygen hose from the Compressed Oxygen Cylinder with regulator to the 731-9130 (or equivalent) Oxygen flowmeter input.
- 5.11.5.2. Open the Compressed Oxygen Cylinder valve and adjust the pressure regulator to 50 ± 5 psi and flow through the Oxygen flowmeter to ~ 1 L/min.
- 5.11.5.3. Connect the O<sub>2</sub> dedicated Calibration Circuit (738-1850) from the Oxygen flowmeter output to the AeroNOx 2.0™ sample port.
- 5.11.5.4. Enter calibration mode again and select “High Cal”, then “O<sub>2</sub>”. Allow the AeroNOx 2.0™ to sample 100% oxygen for 2 minutes. Use arrows to set O<sub>2</sub> value to 100%. **Record this by placing a checkmark in the corresponding box on the AeroNOx 2.0™ Gas Testing Record Form.** If the analyzer is still out of specification or will not hold a 100% measurement, the analyzer is nonconforming. Follow standard operating procedures for nonconforming product.
- 5.11.5.5. Disconnect the O<sub>2</sub> Calibration Circuit and close the Oxygen Cylinder valve.

**NOTE:**

*The use of a low volume shutoff valve is permitted, but each gas must be on an isolated flow path to prevent gas cross contamination.*

## 5.11.6. Nitric Oxide (NO) Gas Testing

### 5.11.6.1. NO Calibration

5.11.6.1.1. Ensure that the AeroNOx 2.0™ complete with sensors to be calibrated has been plugged in for at least 48 hours prior to being gas tested. This will ensure that the NO sensor has biased properly.

**NOTE:** *This time can be reduced if the NO sensor has been biased correctly for at least 48 hours.*

5.11.6.1.2. Power on the AeroNOx 2.0™ and enter calibration mode if not already there.

5.11.6.1.3. Note that the AeroNOx 2.0™ accuracy is  $\pm 1$  ppm for NO, so displayed values need to be within this specification.

5.11.6.1.4. Purge the EPA Protocol Gas, 80 ppm NO, Balance Nitrogen Cylinder.

5.11.6.1.5. Connect the 80 ppm NO dedicated 201-0055 Female CGA 660 to Male CGA 625 Adapter to the 80 ppm NO Cylinder and the 80 ppm NO dedicated 731-9141 Calibration Regulator. Connect the 80 ppm NO dedicated 738-1850 Calibration Circuit to the 80 ppm NO Calibration Regulator. Open the 80 ppm NO Cylinder valve for 30 seconds to flush the circuit.

5.11.6.1.6. Connect the sample line plug of the 80 ppm NO Calibration Circuit to the AeroNO2.0™ sample port.

5.11.6.1.7. Select “High Cal”, then “NO”. Allow the AeroNOx 2.0™ to sample NO for approximately 5 minutes or until stable. Use arrows to set NO value to match bottle calibration (e.g. 80 ppm). **Record bottle cal value and high cal set value on the AeroNOx 2.0™ Gas Testing Record Form.** If the set value maxes out without matching the bottle calibration or will not hold a stable NO measurement, the analyzer is nonconforming. Follow standard operating procedures for nonconforming product.

5.11.6.1.8. Disconnect the 80 ppm NO Calibration circuit and close the 80 ppm NO Cylinder valve. Open the Oxygen Cylinder valve and connect the O<sub>2</sub> Calibration Circuit to the AeroNOx 2.0™ sample port. Ensure that the displayed NO value returns to 0-1 ppm and O<sub>2</sub> goes to 98-100%. **Record “Re-check Zero” value on Gas Testing Record Form for NO.**

5.11.6.1.9. Disconnect the O<sub>2</sub> Calibration circuit and close the Oxygen Cylinder valve. Open the 80 ppm NO Cylinder valve and connect the 80 ppm NO Calibration Circuit to the AeroNOx 2.0™ sample port. Wait for at least 2 minutes for the gas concentrations to stabilize. Ensure the displayed NO value returns to the established high cal value. **Record** this value on the corresponding line for “**Re-check High Span**” on the AeroNOx 2.0™ Gas Testing Record Form. If it does not, repeat high cal once or twice. If these steps have already been repeated, it is probable that the NO sensor may have expired. Remove the AeroNOx 2.0™ from testing and follow approved procedures for non-conforming product.

#### 5.11.6.2. NO Mid-Range Reference Testing

5.11.6.2.1. Disconnect the 80 ppm NO Calibration Circuit and close the 80 ppm NO Cylinder valve.

5.11.6.2.2. Purge the EPA Protocol Gas, 45 ppm NO, Balance Nitrogen Cylinder.

5.11.6.2.3. Connect the 45 ppm NO dedicated 201-0055 Female CGA 660 to Male CGA 625 Adapter to the 45 ppm NO Cylinder and the 45 ppm NO dedicated 731-9141 Calibration Regulator. Connect the 45 ppm NO dedicated 738-1850 Calibration Circuit to the 45 ppm NO Calibration Regulator. Open the 45 ppm NO Cylinder valve for 30 seconds to flush the circuit.

5.11.6.2.4. Connect the sample line plug of the 45 ppm NO Calibration Circuit to the AeroNOx 2.0™ sample port. Allow the AeroNOx 2.0™ to sample NO for approximately 5 minutes or until stable. **Record bottle cal value and AeroNOx2.0 NO reading on the AeroNOx 2.0™ Gas Testing Record Form.** If the AeroNOx 2.0™ NO reading does not match the bottle cal value within  $\pm 1$  ppm or will not hold a stable NO measurement, the analyzer is nonconforming. Follow standard operating procedures for nonconforming product.

#### 5.11.7. **Nitrogen Dioxide (NO<sub>2</sub>) Gas Testing**

##### 5.11.7.1. NO<sub>2</sub> Calibration

Repeat the steps for NO Calibration (Section 5.11.6.1.) substituting NO<sub>2</sub> in place of NO noting the following differences:

5.11.7.1.1. Note that the AeroNOx 2.0™ accuracy is  $\pm 0.1$  ppm for NO<sub>2</sub>, so displayed values need to be within this specification.

5.11.7.1.2. Use EPA Protocol Gas, 9 ppm Nitrogen Dioxide, Balance Air for the High Cal gas.

5.11.7.1.3. Use the 9 ppm NO<sub>2</sub> dedicated CGA Adapter, Calibration Circuit, and Calibration Regulator.



#### 5.11.7.2. NO<sub>2</sub> Mid-Range Reference Testing

Repeat the steps for NO Mid-Range Reference Testing (Section 5.11.6.2.) substituting NO<sub>2</sub> in place of NO, noting the following differences.

5.11.7.2.1. Note that the AeroNOx 2.0™ accuracy is  $\pm 0.1$  ppm for NO<sub>2</sub>, so displayed values need to be within this specification.

5.11.7.2.2. Use EPA Protocol Gas, 5 ppm Nitrogen Dioxide, Balance Air for the Mid-Range Reference gas.

5.11.7.2.3. Use the 5 ppm NO<sub>2</sub> dedicated CGA Adapter, Calibration Circuit, and Calibration Regulator.

#### 5.11.7.3. NO<sub>2</sub> Alarm Testing

Check the alarm function by ensuring that:

- The audible and visual alarms are activated when the displayed NO<sub>2</sub> value is at (or above) the value set on the “HI” alarm.
- The alarm turns off when the “HI” alarm is adjusted up until it is 1 ppm above the displayed NO<sub>2</sub> value.

**Record that the High NO<sub>2</sub> alarm is functioning by placing a checkmark in the corresponding box on the AeroNOx 2.0™ Gas Testing Record Form.**

#### 5.11.7.4. NO Safety Shutoff Alarm

Check the safety shutoff alarm function by ensuring that:

5.11.7.4.1. When the displayed NO value exceeds the “HI” alarm limit set on the display by 5 ppm (or more), the audible alarm activates and the AeroNOx 2.0™ display alternates between the message “NITRIC OFF” and the measured NO and NO<sub>2</sub> values. Set “HI” alarm limit by 5 ppm or more above sampled NO value and observe. **Record this by placing a checkmark in the corresponding box for “Safety Shutoff: Alarm” on the AeroNOx 2.0™ Gas Testing Record Form.** Ensure that there is no gas flow from the AeroNOx 2.0™ delivery line. This can be verified using an AeroNOx 2.0™ delivery line and a cup of water to check for bubbles. **Record this by placing a checkmark in the corresponding box for “Safety Shutoff: Test” on the AeroNOx 2.0™ Gas Testing Record Form.**

5.11.7.4.2. While in “NITRIC OFF” alarm condition, simultaneously pressing and holding the back and alarm silence buttons for 5 seconds enables the safety shutoff override. The display should read “SAFETY OFF” once the safety shutoff has been overridden. Ensure that “SAFETY OFF” is not displayed before 5 seconds has elapsed. Ensure that the AeroNOx 2.0™ display now alternates between the message “SAFETY OFF” and the measured NO and NO<sub>2</sub> values. Since the safety system has been deactivated, ensure that there is gas flow from the AeroNOx 2.0™ delivery line. This can be verified using an AeroNOx 2.0™ delivery line and a cup of water to check for bubbles. **Record this by placing a checkmark in the corresponding box for “Safety Shutoff: Override Test” on the AeroNOx 2.0™ Gas Testing Record Form.**

5.11.7.4.3. While the safety shutoff is overridden, power the AeroNOx 2.0™ off then power the AeroNOx 2.0™ back on. This re-activates the safety shutoff and the AeroNOx 2.0™ delivery and alarms should function as normal.

5.11.7.5. NO Alarm Testing

Check the alarm function by ensuring that:

- The audible and visual alarms are activated when the displayed NO value is at (or above) the high alarm value set on the display.
- The audible and visual alarms are activated when the displayed NO value is at (or below) the low alarm value set on the display.
- The alarm turns off when the “HI” alarm value is adjusted up until it is 1 ppm above the displayed NO value.
- The alarm turns off when the “LOW” alarm value is adjusted down until it is 1 ppm below the displayed NO value.

**Record that the High and Low NO alarms are functioning by placing checkmarks in the corresponding boxes on the AeroNOx 2.0™ Gas Testing Record Form.**

#### 5.11.7.6. NO<sub>2</sub> Safety Shutoff Alarm

Check the safety shutoff alarm function by ensuring that:

5.11.7.6.1. When the displayed NO<sub>2</sub> value exceeds the value set on the “HI” alarm limit by 1 ppm (or more), the audible alarm activates and the AeroNOx 2.0™ display alternates between the message “NITRIC OFF” and the measured NO and NO<sub>2</sub> values. Set “HI” alarm setting by 1 ppm or more above sampled NO<sub>2</sub> value and observe. **Record this by placing a checkmark in the corresponding box for “Safety Shutoff: Alarm” on the AeroNOx 2.0™ Gas Testing Record Form.** Ensure that there is no gas flow from the AeroNOx 2.0™ delivery line. This can be verified using an AeroNOx 2.0™ delivery line and a cup of water to check for bubbles. **Record this by placing a checkmark in the corresponding box for “Safety Shutoff: Test” on the AeroNOx 2.0™ Gas Testing Record Form.**

5.11.7.6.2. While in safety shutoff alarm condition, simultaneously pressing and holding the NO and NO<sub>2</sub> alarm silence buttons for 5 seconds enables the safety shutoff override. The display should read “SAFETY OFF” once the safety shutoff has been overridden. Ensure that the AeroNOx 2.0™ display now alternates between the message “SAFETY OFF” and the measured NO and NO<sub>2</sub> values. Since the safety system has been deactivated, ensure that there is gas flow from the AeroNOx 2.0™ delivery line. This can be verified using an AeroNOx 2.0™ delivery line and a cup of water to check for bubbles. **Record this by placing a checkmark in the corresponding box for “Safety Shutoff: Override Test” on the AeroNOx 2.0™ Gas Testing Record Form.**

5.11.7.6.3. While the safety shutoff is overridden, power the AeroNOx 2.0™ off then power the AeroNOx 2.0™ back on. This re-activates the safety shutoff and the AeroNOx 2.0™ delivery and alarms should function as normal.

5.11.8. **Sign and date the AeroNOx 2.0™ Gas Testing Record Form** and any other accompanying documentation required.

The unit is now ready for QA Final Inspection, which should occur soon after to prevent discrepancies in testing. A test battery should still be installed to maintain bias achieved during initial calibration.

## AeroNOx 2.0™ Gas Testing Record Form

AeroNOx 2.0™ S/N: _____		Date: _____		Time: _____	
MFM Flow/Leak Check and Sample Flow Calibration		<input type="checkbox"/> Procedures Completed			
Battery / Charge Indicators:		<input type="checkbox"/> Battery Indicator		<input type="checkbox"/> Charge Indicator	
Zero Calibration:		<input type="checkbox"/> O <sub>2</sub> =21%		<input type="checkbox"/> NO=0 ppm	
				<input type="checkbox"/> NO <sub>2</sub> =0.0 ppm	
O <sub>2</sub> High Calibration		<input type="checkbox"/> O <sub>2</sub> =100%			

Calibration Results					
NITRIC OXIDE (NO)			NITROGEN DIOXIDE (NO <sub>2</sub> )		
High Cal Gas Label:	_____	ppm	High Cal Gas Label:	_____	ppm
High Cal Set:	_____	ppm	High Cal Set:	_____	ppm
Re-check Zero:	_____	ppm	Re-check Zero:	_____	ppm
Re-check High Span:	_____	ppm	Re-check High Span:	_____	ppm

Mid-Range Reference Results					
NITRIC OXIDE (NO)			NITROGEN DIOXIDE (NO <sub>2</sub> )		
Reference	Actual		Reference	Actual	
_____	_____		_____	_____	
ppm	ppm		ppm	ppm	

Alarms Testing					
NITRIC DIOXIDE (NO <sub>2</sub> )			NITROGEN OXIDE (NO)		
	<input type="checkbox"/> High Alarm		<input type="checkbox"/> Low Alarm	<input type="checkbox"/> High Alarm	
Safety Shutoff:	<input type="checkbox"/> Alarm		Safety Shutoff:	<input type="checkbox"/> Alarm	
	<input type="checkbox"/> Test			<input type="checkbox"/> Test	
	<input type="checkbox"/> Override Test			<input type="checkbox"/> Override Test	

Pass / Fail: \_\_\_\_\_

Inspected by: \_\_\_\_\_ (print name)      \_\_\_\_\_ (signature)      \_\_\_\_\_ (date)

## 5.12. Repair Maintenance

### 5.12.1. Front External Layout

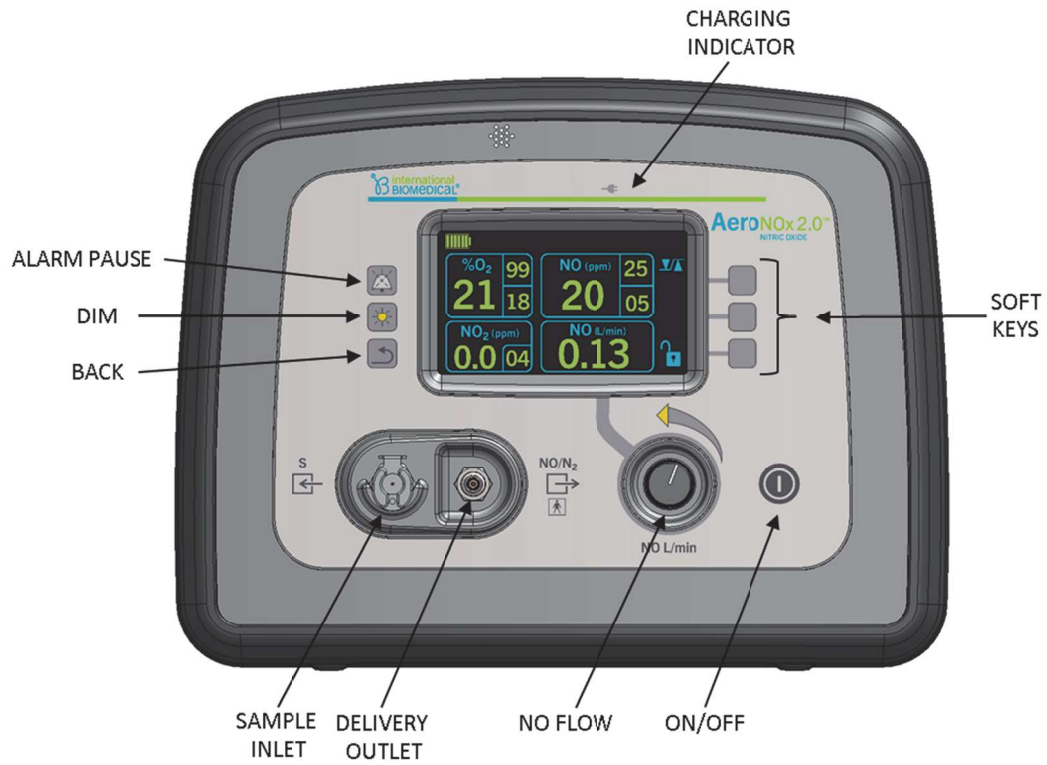

### 5.12.2. Rear External Layout

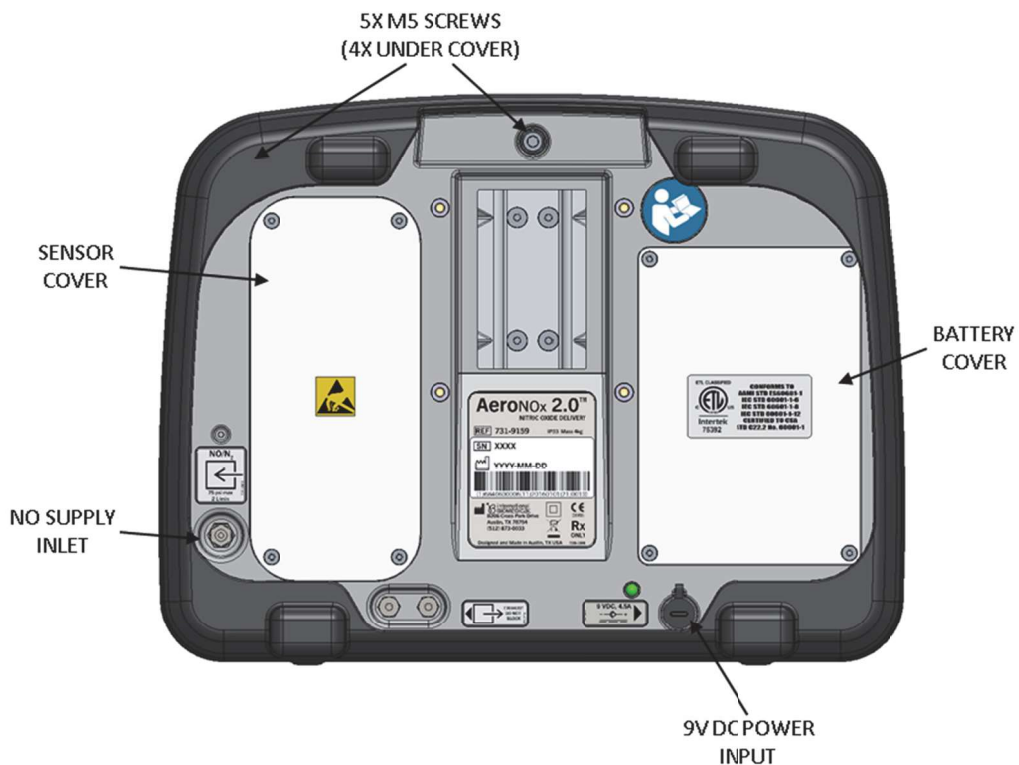

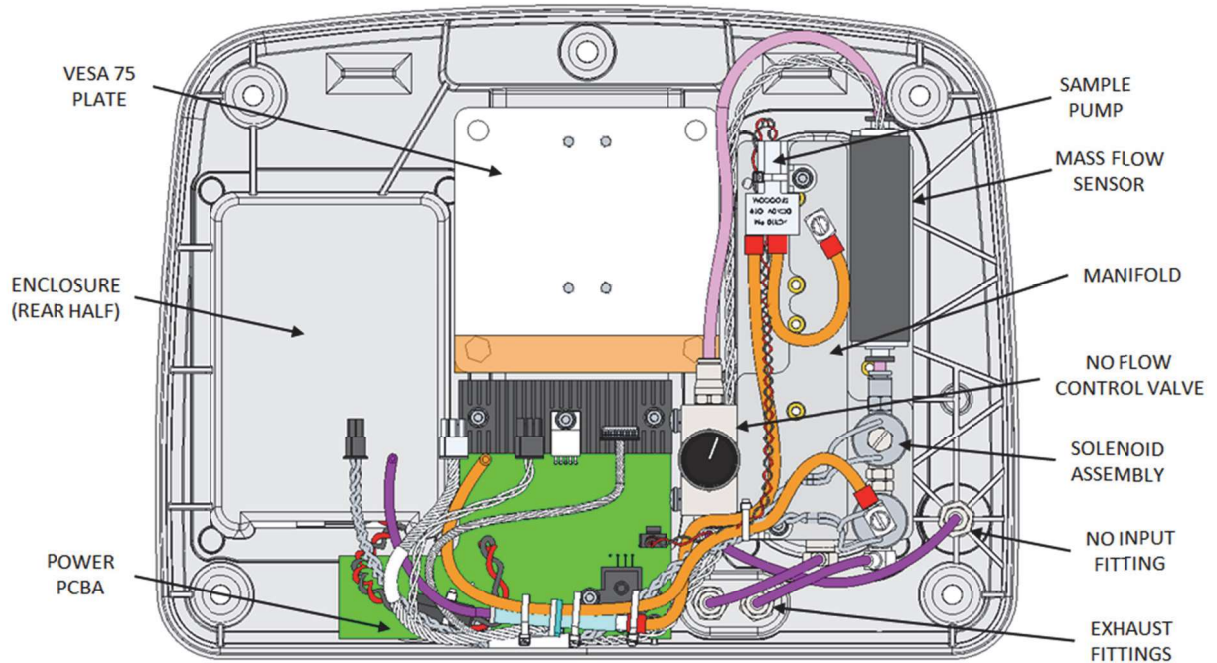

### 5.12.3. Rear Internal Layout



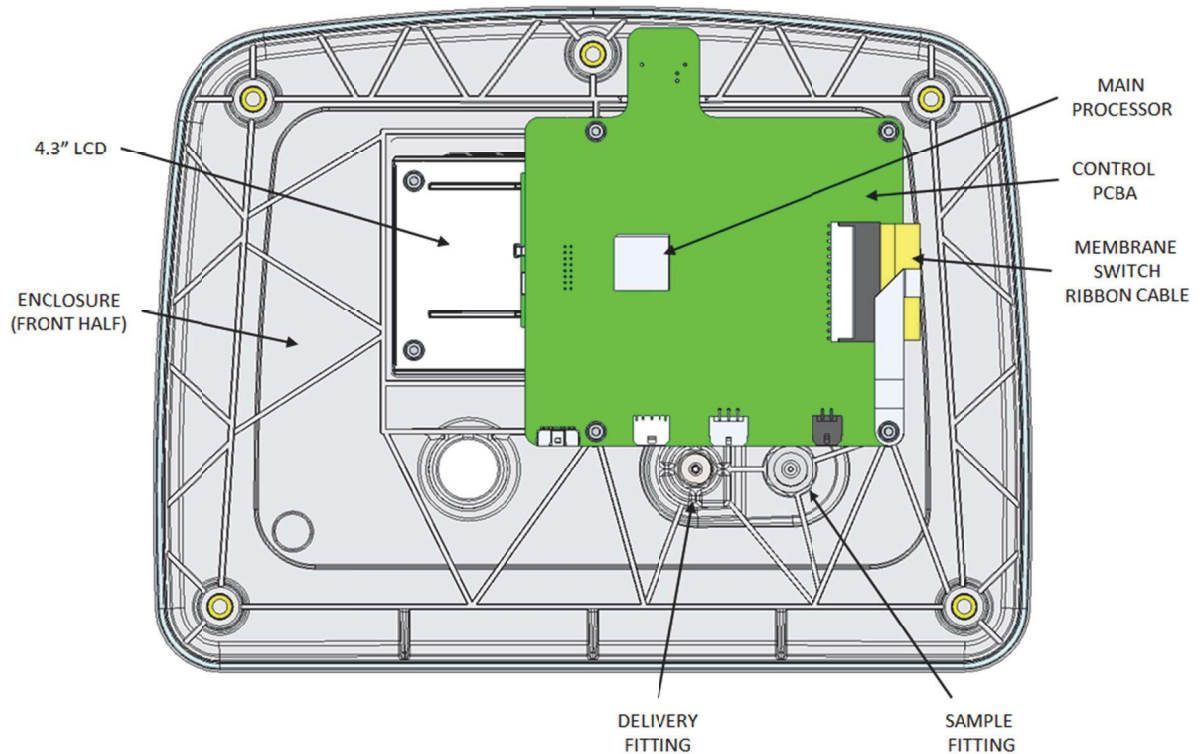

### 5.12.4. Front Internal Layout

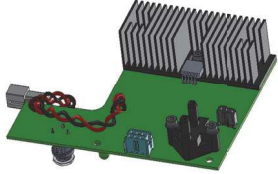
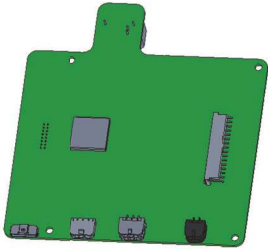
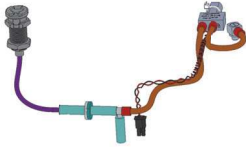
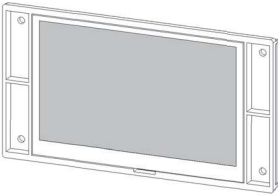
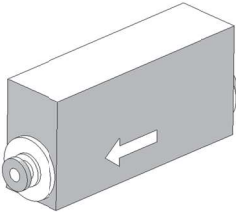

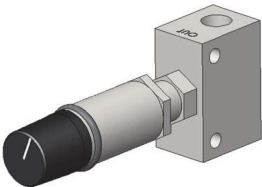
### 5.12.5. Service Parts List

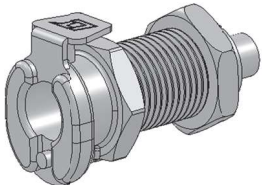
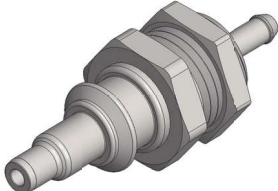
Component/Subassembly	Part Number	
Power PCBA, SLA	723-0007	
Power PCBA, LiFePO <sub>4</sub>	723-0008	
Control PCBA w/ Processor	723-0001-XX	
Sample Pump Assembly	723-0005	
AeroNOx 2.0 4.3" LCD	738-1908	
Mass Flow Meter	738-1835	
External Fastener Kit w/ Cover Plates	723-0006	
Porter Valve Assembly	723-0004	

Component/Subassembly	Part Number	
Sample Inlet Port	738-1905	
Delivery Gas Outlet Port	738-1846	
NO/N2 Gas Input Port	738-1814	
Protective Cover	738-1934	

Service parts may be obtained from your AeroNOx 2.0™ distributor or representative. Consumable parts are listed in the Operator's Manual.

**NOTE:** *Always use direct replacement parts. Substitutions may reduce performance or safety.*

#### **Parts Not Listed**

If service to a part not listed is required, contact International Biomedical for factory repair.

#### **ORDERING PARTS**

When ordering replacement parts for this instrument from International Biomedical, please include the following information:

1. Type or name of the instrument
2. Serial number of the instrument
3. A complete description of the part, including component or reference number if available
4. Part number from the Service Parts list.



#### 5.12.6. **General Disassembly**

- a) Remove the protective boot. Start at top front corners and slip the boot backwards. Then slip the bottom front corners of the boot backwards.
- b) Remove battery cover, disconnect battery cable, and remove battery.
- c) Remove five M5 screws holding enclosure together. Do not lose sealing washers.
- d) Carefully flip open enclosure as if hinged from the bottom edge.

#### 5.12.7. **Power PCBA**

- a) Remove nut and rubber plug on power input connection using a 3/8" thin walled socket.
- b) Perform general disassembly.
- c) Unplug sample pump and main board to board cable.
- d) Remove tube from pressure sensor, breaking glue joint. Note that it must be reconnected to the same barb upon reassembly (barb closest to wall).
- e) Snip zip tie retaining ferrite on battery cable.
- f) Remove ferrite for reuse.
- g) Unscrew four M3 screws (2.5 mm hex). Note that the screw in the center of the heat sink is not removed.
- h) Remove board.
- i) Ensure that the rubber gasket for the LED does not come off. If it does, reapply it before reassembly.
- j) Use a small zip tie (not provided) to secure tube to barb on pressure sensor.
- k) Replace board and re-assemble in reverse order.

#### 5.12.8. **Control PCBA**

- a) Perform General disassembly.
- b) Unplug four cables.
- c) Unscrew four M3 screws (2.5 mm hex).
- d) Unplug ribbon cable.
- e) Unplug PCBA from LCD stacking connector.
- f) Reverse order to reassemble.

#### 5.12.9. **AeroNOx 2.0™ 4.3" LCD**

- a) Perform steps to remove Control PCBA.
- b) Unscrew four M3 screws (2.5 mm hex) holding LCD.
- c) Reverse order to re-assemble. Bias the display within the oversized holes so it is horizontal.

#### 5.12.10. **Sample Assembly**

- a) Perform General disassembly.
- b) Unplug sample pump from power PCBA.

- c) Unscrew sample pump retaining clamp.
- d) Remove right angle barb fitting from manifold.
- e) Remove tube from pressure sensor, breaking glue joint. Note that it must be reconnected to the same barb upon reassembly (barb closest to wall).
- f) Snip the zip tie bundling the tubes and cables. Note that it is not pinching the tube closed.
- g) Disconnect tube from sample fitting.
- h) Remove sample fitting (optional).
- i) Replace in reverse order.
- j) Replace the zip tie that was removed. Do not pinch the tube.
- k) Reverse order to reassemble.

#### 5.12.11. **Mass Flow Meter (MFM)**

- a) Perform general disassembly.
- b) Remove the four M3 screws from the sensor cover.
- c) Remove the sensor cover.
- d) Unplug the O<sub>2</sub> sensor and the sensor cable from the sensor board.
- e) Remove six Phillips head screws retaining the sensor board (#2 Phillips).
- f) Remove three M5 screws retaining manifold (4 mm hex).
- g) Lift manifold out partially to access MFM screws.
- h) Disconnect cable from MFM.
- i) Disconnect 4 mm tube from inlet push to connect fitting.
- j) Remove two M3 screws.
- k) Disconnect 4 mm outlet tube from push to connect fitting.
- l) Reverse order to reassemble.

#### 5.12.12. **Porter Valve Assembly**

- a) Perform power PCBA removal steps to gain access to the Porter Valve.
- b) Remove two 8-32 screws (#1 Phillips).
- c) Disconnect 4 mm tube from push to connect.
- d) Slide lock collar up ~1/2" and disconnect 1/8" tube from inlet fitting.
- e) The Porter Valve can now be freely removed.
- f) Unscrew the 4 mm push-to-connect fitting and 1/8" barb fitting.
- g) Re-apply Teflon tape as required and install the fittings on the replacement Porter Valve. Inlet & Exit are marked on the valve. The 4 mm push-to-connect goes on the exit side. The 1/8" barb fitting goes on the inlet side, oriented roughly pointed up for tube routing.
- h) Reverse order to reassemble.

5.12.13. **Sample Inlet Port**

- a) Perform general disassembly.
- b) Perform Control PCBA removal steps as required for easier access to the sample inlet port nut.
- c) Disconnect 1/8" tube from the sample fitting.
- d) Remove the sample fitting (5/8" Socket).
- e) Reverse order to reassemble.

5.12.14. **Delivery Port**

- a) Perform general disassembly
- b) Perform Control PCBA removal steps as required for easier access to the delivery port nut.
- c) Slide the tube collar up the tube ~1/2".
- d) Disconnect the 5/32" tube.
- e) Remove the nut from the fitting (1/2" socket).
- f) Reverse order to reassemble.

5.12.15. **NO/N<sub>2</sub> Inlet Port**



- a) Perform general disassembly
- b) Slide the tube collar up the tube ~1/2".
- c) Disconnect the 1/8" tube from the barb.
- d) Unscrew the barb fitting from the Inlet port. (3/8" socket)
- e) Remove the nut on the fitting. (7/16" socket)
- f) Reverse order to reassemble.

## 6. TROUBLESHOOTING

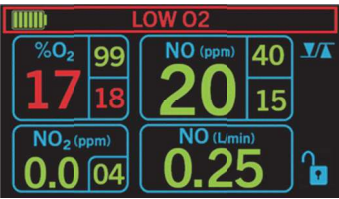
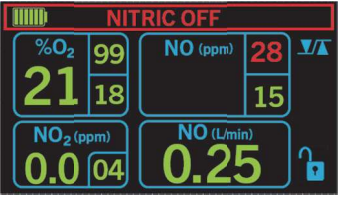

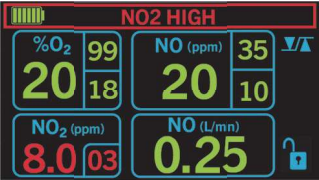
### 6.1. Troubleshooting Alarms Guide

High Priority Alarms		
High Priority Alarms	Possible Cause	Recommended Action
 <p><b>O<sub>2</sub> Low &lt; 18%</b></p>	1. Alarm is set inappropriately	Make sure alarm is set appropriately for the O <sub>2</sub> setting delivered on the ventilator.
	2. O <sub>2</sub> calibration may have drifted.	a. Perform a low and high range calibration on the O <sub>2</sub> sensor. b. Change the O <sub>2</sub> sensor if the unit fails to calibrate. c. Contact International Biomedical Tech Support.
	3. The O <sub>2</sub> sensor may not be seated properly	Make sure sensor is seated with O-ring sealing to manifold.
	4. O <sub>2</sub> displaced by NO, N <sub>2</sub> or NO <sub>2</sub> in ventilator circuit.	Remove patient from circuit and ventilate with INOstat Bagger.
 <p><b>Nitric Off</b></p>	1. NO analyzed has exceeded set high NO alarm limit by 5 ppm.	a. Disconnect patient and manually ventilate with INOstat Bagger, Operator's Manual Section 3. b. See NO high alarm recommended action.
	2. NO analyzed has exceeded 99 ppm	a. Disconnect patient and manually ventilate with INOstat Bagger, Operator's Manual Section 3. b. See NO high alarm recommended action.
	3. NO <sub>2</sub> analyzed has exceeded set high NO <sub>2</sub> alarm limit by 1 ppm.	a. Disconnect patient and manually ventilate with INOstat Bagger, Operator's Manual Section 3. b. See NO <sub>2</sub> high alarm recommended action.
	4. NO <sub>2</sub> analyzed has exceeded 9ppm.	a. Disconnect patient and manually ventilate with INOstat Bagger. See Operator's Manual Section 3. b. See NO <sub>2</sub> high alarm recommended action.

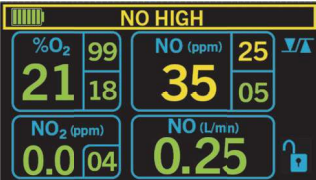

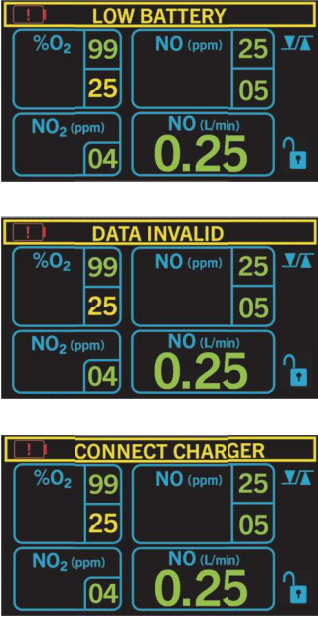

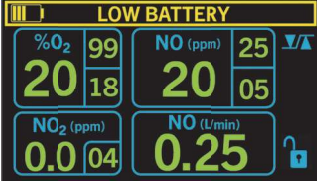
High Priority Alarms		
High Priority Alarms	Possible Cause	Recommended Action
 <p><b>O<sub>2</sub> Low</b></p>	1. Alarm is set inappropriately	a. Make sure alarm is set appropriately for the O <sub>2</sub> setting delivered on the ventilator.
	2. O <sub>2</sub> calibration may have drifted.	a. Perform a low and high range calibration on the O <sub>2</sub> sensor. b. Change the O <sub>2</sub> sensor if the unit fails to calibrate. c. Contact International Biomedical Tech Support.
	3. O <sub>2</sub> concentration on the ventilator was reduced.	Make sure O <sub>2</sub> setting on the ventilator is correct for the O <sub>2</sub> setting on the AeroNOx 2.0™.
	4. The O <sub>2</sub> sensor may not be seated properly	Make sure sensor is seated and with O-rings and housing cover fully closed.
 <p><b>NO<sub>2</sub> High</b></p>	1. Incomplete purge of system.	Perform purge. See the Operator's Manual Section 2., Pre-use Checkout.
	2. Ventilator flow stopped	Allow ventilator gas to flush circuit and stabilize before connecting to patient.
	3. NO <sub>2</sub> alarm limit is set too low.	Make sure NO <sub>2</sub> alarm limit is set to appropriate level.
	4. NO <sub>2</sub> calibration may have drifted.	Perform a low and high range calibration on the NO <sub>2</sub> sensor.
	5. Out of date or wrong calibration gas used.	a. Verify calibration gas expiration date. b. Replace calibration gas and perform a low and high range calibration on the NO <sub>2</sub> sensor.
	6. The patient circuit setup is incorrect.	Ensure circuit is setup according to Operator's Manual Section 3.
	7. Sample line blocked.	Confirm if NO <sub>2</sub> high alarm occurs concurrently with "SAMPLE BLOCKED" message.
	8. The AeroNOx 2.0™ may have failed.	a. Contact International Biomedical Technical Support. b. Replace delivery system if in use.

Medium Priority Alarms		
Medium Priority Alarms	Possible Cause	Recommended Action
 <p><b>SAMPLE BLOCKED</b></p>	1. Water contaminates sample line or filter.	Replace filter or sample line.
	2. Sample line may be blocked or pinched.	<ol style="list-style-type: none"> <li>Make sure sample line an outlet ports are not obstructed.</li> <li>Change sample line.</li> </ol>
 <p><b>O<sub>2</sub> High</b></p>	1. Alarm is set inappropriately	<ol style="list-style-type: none"> <li>Make sure alarm is set appropriately for the O<sub>2</sub> setting delivered on the ventilator.</li> </ol>
	2. O <sub>2</sub> calibration may have drifted.	<ol style="list-style-type: none"> <li>Perform a low and high range calibration on the O<sub>2</sub> sensor.</li> <li>Change the O<sub>2</sub> sensor if the unit fails to calibrate.</li> <li>Contact International Biomedical Tech Support.</li> </ol>
 <p><b>NO High</b></p>	1. New installed NO sensors will give a high reading until fully biased (48 hrs) and calibrated.	<ol style="list-style-type: none"> <li>After installation of NO sensor perform a high and low calibration.</li> <li>Wait 48 hrs and repeat high and low calibration.</li> </ol>
	2. The NO high alarm is inappropriately set.	Make sure the NO high alarm is set greater than measured value.
	3. The NO calibration may have drifted.	Perform a low and high range calibration of NO sensor.
	4. Circuit setup is incorrect.	Check circuit for correct setup.
	5. Out of date or wrong calibration gas used.	<ol style="list-style-type: none"> <li>Verify calibration gas expiration date.</li> <li>Replace calibration gas and perform a low and high range calibration on the NO<sub>2</sub> sensor.</li> </ol>

Medium Priority Alarms		
Medium Priority Alarms	Possible Cause	Recommended Action
 <p><b>Alternating: Low Battery Connect Charger Data Invalid</b></p>	<ol style="list-style-type: none"> <li>Battery voltage has dropped to a point where data is no longer accurate.</li> </ol>	<ol style="list-style-type: none"> <li>Disconnect patient and manually ventilate with INOstat Bagger. See Operator's Manual Section 3.</li> <li>Plug AeroNOx 2.0™ into AC outlet.</li> </ol>

Low Priority Alarms		
Low Priority Alarms	Possible Cause	Recommended Action
 <p><b>Low Battery</b></p>	<ol style="list-style-type: none"> <li>Battery is running low approximately 5 minutes until depletion.</li> </ol>	<ol style="list-style-type: none"> <li>Connect to AC power source.</li> <li>If connected to AC powers ensure green charging light is on and cord is fully inserted into socket.</li> </ol>
 <p><b>NO Low</b></p>	<ol style="list-style-type: none"> <li>The patient gas sample line may be disconnected.</li> <li>The NO low alarm may be inappropriately set.</li> <li>The NO calibration may have drifted.</li> <li>The NO sensor may not be properly seated.</li> </ol>	<ol style="list-style-type: none"> <li>Reconnect patient gas sample line.</li> <li>Make sure the set NO low value is above measured parameter.</li> <li>Perform a low and high range calibration on the sensor.</li> <li>Make sure sensor is seated and with O-rings and housing cover fully closed.</li> </ol>

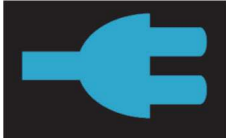
Low Priority Alarms		
Low Priority Alarms	Possible Cause	Recommended Action
	5. Out of date or wrong calibration gas used.	a. Verify calibration gas expiration date. b. Replace calibration gas and perform a low and high range calibration on the NO <sub>2</sub> sensor.

Other Messages		
Indicator	Cause	Recommended Action
	Safety Shut Off system has been deactivated. See Operator's Manual Section 4., Alarms.	a. To reactivate push and hold <b>Silence Alarm</b> key and <b>Back</b> buttons simultaneously.
 <p><b>Battery Power Indicator</b></p>	Device is running on battery	a. Connect to AC power source when available. b. Make sure power cord is fully inserted into socket and green LED power light is illuminated.
 <p><b>AC Power Indicator</b></p>	Device is running on AC power and charging	a. N/A
 <p><b>INTERNAL ERROR</b></p>	a. Battery disconnected or failed b. Other Internal failure	a. Ensure battery connected. b. Contact International Biomedical for service.

Other Problems		
Indicator	Cause	Recommended Actions
Unable to use up arrows to match calibration gas ppm.	Max allowed gain exceeded.	Re-zero. Allow 48 hrs to bias (NO only) Correct leak in sample system. Replace sensors.



## 6.2. Troubleshooting Other Symptoms and Solutions

The following section describes the most common symptoms that are likely to occur with the AeroNOx 2.0™ and suggests the possible solutions.

### SYMPTOMS AND SOLUTIONS

1. Instrument has been sitting for some time. It has not been connected to a charger and the power switch does not turn the instrument on. The sample pump does not run.

*Possible solutions:*

1. *The battery is disconnected, or has become discharged. Connect charger, cycle power, and see if proper operation now occurs. Recharge battery for at least 7 hours.*
2. *The unit has been subjected to a severe ESD occurrence. Disconnect the AC power supply and remove and disconnect battery for a few seconds. Reconnect battery and check operation.*
3. *Replace battery if it fails to charge.*

2. Instrument has been sitting for some time. It has not been connected to a charger. When charger was connected and the unit turned on, very high NO values are indicated on the LCD and the alarms are sounding.

*Possible solutions:*

1. *The battery has become deeply discharged and the instrument has been unable to maintain the bias voltage on the NO sensor. Connect charger and allow battery to charge and the instrument to bias the NO sensor for at least 48 hours before attempting to calibrate the instrument and take measurements.*
2. *If battery fails to take a charge, replace the battery.*

3. Oxygen analyzer will not calibrate to room air of 21% O<sub>2</sub>.

*Possible solution:*

1. *Check the output of the O<sub>2</sub> sensor for approximately 10 mV output in room air. If < 9 mV, replace sensor.*
2. *Check cable and connectors connecting the sensor to the circuit board.*

4. Oxygen analyzer will not calibrate to 100% O<sub>2</sub>.

*Possible solutions:*

1. *Check the output of the O<sub>2</sub> sensor for approximately 10 mV output in room air. If < 9 mV, replace sensor. 13 mV is expected at 100% O<sub>2</sub>.*
2. *If sensor checks OK above, check plumbing, tubing, and connections for leaks in the system. Ambient air is probably being drawn into the system. Repair leaks.*
3. *Check cable and connectors connecting the sensor to the circuit board.*

5. NO or NO<sub>2</sub> sensors are very slow to respond or response is very low.

- Possible solutions:*
1. *Sample flow rate low. Verify flow rate is 120-220 mL/min. Replace old pump, failed orifice, or adjust sample flow rate potentiometer.*
  2. *Sensor may be old and the catalyst has been depleted. Check the date code on the sensor - the last 3 digits of the serial number represent the month and year (e.g., 126 = December 2016). Under proper conditions of use, sensor life is approximately 12 months. Replace sensor, allow time to bias, and check operation.*
  3. *Sensor may have been exposed to gases or conditions that have damaged or contaminated the sensor. Replace sensor, allow time to bias, and check operation.*
  4. *System may have gas leaks. Check tubing and connections for leaks. Repair leaks if any are found.*
  5. *Check status of calibration gases for shelf life or contamination.*

6. NO or NO<sub>2</sub> values will not reach the calibration values.

- Possible solutions:*
1. *See possible solutions for NO or NO<sub>2</sub> very slow to respond (Symptom #5).*

7. NO or NO<sub>2</sub> values will not stabilize. Values drift while calibrating.

- Possible solutions:*
1. *See possible solutions for NO or NO<sub>2</sub> very slow to respond (Symptom #5).*
  2. *Check wiring harness and connectors that connect the sensors to the circuit boards for loose wires or intermittent connections.*
  3. *NO sensor may not be properly biased. Allow more time.*

8. NO or NO<sub>2</sub> will not respond at all to gas.

- Possible solutions:*
1. *See possible solutions for NO or NO<sub>2</sub> very slow to respond (Symptom #5).*
  2. *Check wiring harness and connectors that connect the sensors to the circuit boards for loose wires or intermittent connections.*

9. NO or NO<sub>2</sub> values drift while instrument is in use.

- Possible solutions:*
1. See possible solutions for NO or NO<sub>2</sub> very slow to respond (Symptom #5).
  2. Check wiring harness and connectors that connect the sensors to the circuit boards for loose wires or intermittent connections.
  3. Incomplete gas mixing may be occurring in the patient circuit. Refer to "Operator's Manual" for proper connections and minimum mixing length from delivery site to sample site on ventilator circuit.

10. NO<sub>2</sub> value displayed is "HI" and does not change.

- Possible solutions:*
1. NO<sub>2</sub> sensor has been exposed to gas concentrations in excess of 10 ppm. Flush the system with room air or oxygen for a period of time until the value returns to zero.
  2. NO<sub>2</sub> sensor has been damaged by overexposure. Replace the sensor.

11. NO sensor value will not return to zero.

- Possible solutions:*
1. Perform Low and High Calibration.
  2. NO sensor has been exposed to concentrations of NO > 100 ppm. Flush system with room air or oxygen until value returns to zero. Exposure to high concentrations of gas will shorten sensor life.

12. "HI" or "LO" displayed continuously on one of the displays.

- Possible solutions:*
1. Sensors have drifted above max limit or below zero. Recalibrate per the "Operator's Manual".
  2. Sensors are not biased. Make sure internal battery was connected and charged for at least 48 hours prior to use.
  3. Sensors are old. Check PM schedule.
  4. Enter calibration mode for numeric display of actual values to aid troubleshooting. Operating mode masks numeric values outside of the useable range.

13. "SAMPLE BLOCKED" displayed immediately when turned on.

- Possible solutions:*
1. Sample line, hydrophobic filter, or Nafion line has plugged off. Disconnect filter and lines from instrument and try again. If it operates correctly, check lines and filter for plugging, reconnect, and try unit again.

2. *Foreign material may have been drawn into instrument and has blocked the sampling system. Check and clean if necessary.*
3. *Pressure transducer that detects plugged lines may have failed. Replace power board.*

14. Mass flow display does not return to zero when no flow is present.

- Possible solutions:*
1. *There is no adjustment for the mass flow sensor. Flow  $\leq 0.01$  L/min is acceptable, however this may indicate an issue if it does not return to zero. Run the MFM Flow Check/Leak Check Procedure and verify MFM accuracy from 0-2.0 L/min. Replace as required.*

15. "SAMPLE BLOCKED" not displayed when sample line intentionally blocked.

- Possible solutions:*
1. *Tube to pressure sensor disconnected or plugged into the wrong port. Note this will also drastically lower the NO, NO<sub>2</sub>, and O<sub>2</sub> sensors' responses.*

All routine maintenance, repairs, and replacement of standard parts should be conducted according to procedures outlined in the Service Manual. For all clinical or technical issues not addressed in the manual, please contact International Biomedical directly at:

<b>Call 1-512-873-0033</b> <b>FAX: 1- 512-873-9090</b>
---

### 6.3. Customer Service

Should you need clinical or technical information, please contact International Biomedical. To help us to help you, please have the following information available:

- A complete description of the problem / observation
- Model #
- Serial #
- Your Institution address
- Your fax #

The above information is necessary to determine warranty status as well as to gather the information necessary for us to fill out a Return Merchandise Authorization (RMA) should you need to send anything back for repair. **Any equipment sent to International Biomedical without an RMA will not be accepted for delivery.** Do not ship any products to International Biomedical without first obtaining an RMA.

## Return Merchandise Authorization

1. To return AeroNOx 2.0™ contact customer service at International Biomedical.
2. Disconnect battery.
3. Pack AeroNOx 2.0™ as requested by customer service along with any requested accessories.
4. Put RMA number on outside of packaging and send to location specified by customer service.

## 7. **APPENDIX**

### 7.1. External Power Supply Electrical Specifications

Parameter	Specification
Medical Rated AC Supply	Meanwell GSM40B09-P2S
Voltage Range	80 - 264 VAC 113 - 370 VDC
Frequency	47 - 63 Hz
Efficiency	86%
AC Current (Typical)	1 A/115 VAC 0.5 A/230 VAC
Inrush Current (Typical)	30 A/115 VAC 65 A/230 VAC
Overload	105 - 160% rated power output Protection Type: Hiccup mode, recovers automatically after fault condition is removed

## 7.2. Isolation Diagram

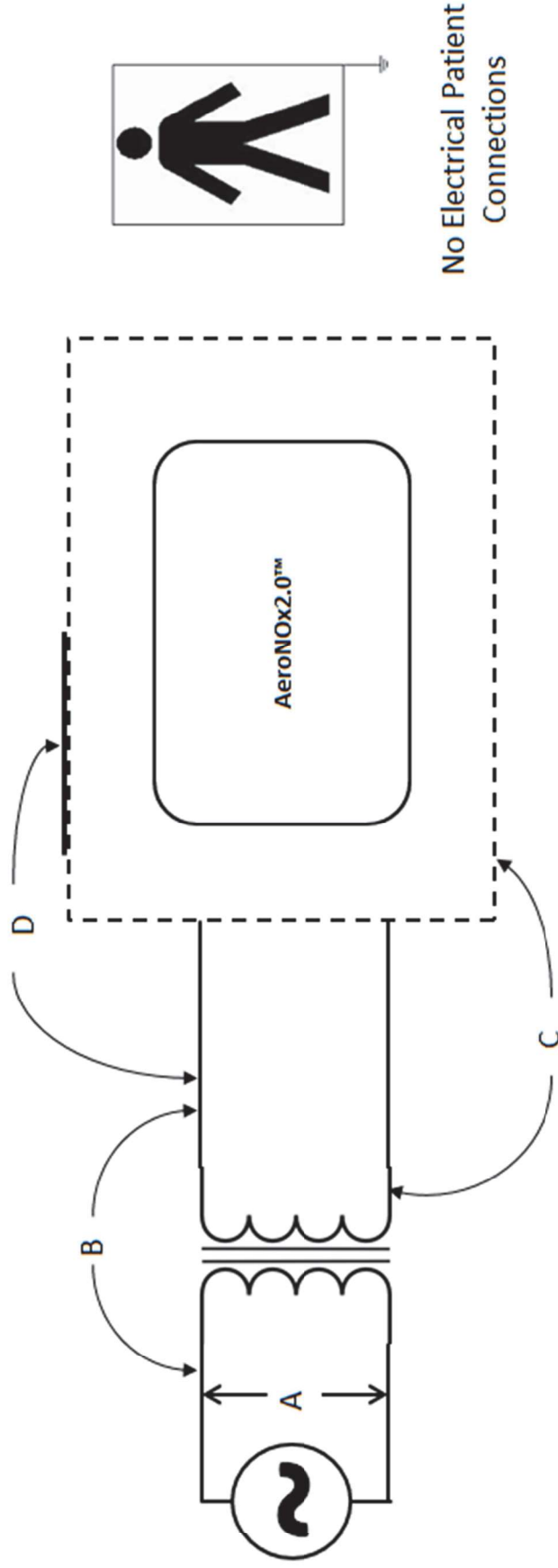

No Electrical Patient  
Connections

Isolation Table

Section	Desc	Insulation Type	Max Voltage
A	Line-Neutral	BI	240Vac
B*	Mains Secondary to LV Secondary	2 MOOP	240Vac
C	Secondary to Accessible	2 MOOP	9Vdc
D	Ungrounded Metal to Secondary	2 MOPP	9Vdc

\* Mains - Secondary isolation through use of 60601 Compliant supply (Mean Well# GSM40B09-P2S, UL FILE # E227340)

## 7.3. Nitric Oxide Sensor Specifications

# Product Data Sheet MNO-1 & MNO-1B MediceLs®

Nitric Oxide (NO) Gas Sensor

Part Numbers: AF0F4-H00 (standard) AF0F7-H00 (with Bias Board)

### Key Features & Benefits:

- Capable of continuous measurement
- 4th electrode for additional temperature stability

### Technical Specifications

#### MEASUREMENT

Operating Principle	4-electrode electrochemical
Measurement Range	0-100 ppm
Maximum Overload	1500 ppm
Output Signal	$0.25 \pm 0.05 \mu\text{A/ppm}$
Response Time ( $T_{90}$ )	< 10 seconds
Typical Baseline Offset (clean air)	-1 to +1 ppm equivalent
Repeatability	2% of signal
Linearity	Linear

#### ELECTRICAL

Recommended Load Resistor	10 $\Omega$
Bias Voltage	+300 mV
Recommended Gain	1.1

#### MECHANICAL

Weight	21 g (nominal)
Housing Material	20% glass-filled polypropylene
Colour Coded Ring	Orange
Orientation	Any

#### ENVIRONMENTAL

Typical Applications	Inhaled Nitric Oxide Therapy
Operating Temperature Range	-20°C to +50°C
Recommended Storage Temp	0°C to +20°C
Operating Pressure Range	800 - 1200 mBar
Differential Pressure Range	$\pm 100$ mBar
Storage Pressure Range	800 - 1200 mBar
Operating Humidity Range	15% to 90% RH non-condensing

#### LIFETIME

Long Term Output Drift	Depends on usage level
Expected Operating Life	1 year
Standard Warranty	12 months from date of despatch

### Product Dimensions

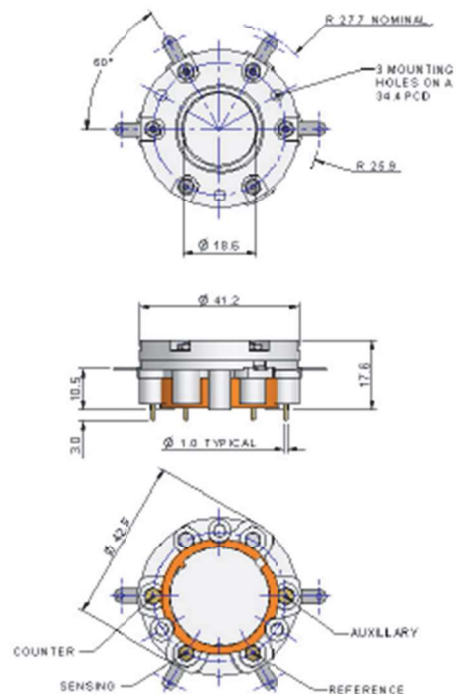

All dimensions in mm  
All tolerances  $\pm 0.15$  mm  
unless otherwise stated

#### IMPORTANT NOTE:

Connection should be made via recommended mating parts only. Soldering to the sensor will damage it and invalidate the warranty.

All performance data is based on measurements made with cylinder gases using a flow rate of 100 ml/min. Conditions at 20°C, 50% RH and 1013 mBar, using City Technology recommended circuitry. For sensor performance data under other conditions, contact City Technology.

# Product Data Sheet

## Continuous Exposure

After continuous exposure to high concentrations of NO for several days the sensor may take some time to stabilise in fresh air before further use is advised. During this recovery period high baseline offsets may be seen. City Technology recommend 24 hours recovery period before reuse following exposures which exceed 4 days at levels of 80 ppm or above.

## Poisoning

CiTiCeLs are designed for operation in a wide range of environments and harsh conditions. However, it is important that exposure to high concentrations of solvent vapours is avoided, both during storage, fitting into instruments and operation.

When using sensors with printed circuit boards (PCBs), degreasing agents should be used before the sensor is fitted. Do not glue directly on or near the CiTiCeL as the solvent may cause crazing of the plastic.

## Cross Sensitivity Table

Whilst CiTiCeLs are designed to be highly specific to the gas they are intended to measure, they will still respond to some degree to various gases. The table below is not exclusive and other gases not included in the table may still cause a sensor to react.

<u>Gas</u>	<u>Response</u>
Carbon Monoxide (CO)	None
Nitrous Oxide (N <sub>2</sub> O)	None
Nitrogen Dioxide (NO <sub>2</sub> )	<25%
Desflurane	None
Isoflurane	None
Halothane	None

### **SAFETY NOTE**

Although this product is not designed for use in life safety applications, if it is used in such applications it is a requirement that the function of the device is confirmed by exposure to target gas (bump check) before each use of the sensor and/or instrument, to ensure that the sensor and/or instrument in which it is used, are operating properly. Failure to carry out such tests may jeopardize the safety of people and property.

Every effort has been made to ensure the accuracy of this document at the time of printing. In accordance with the company's policy of continued product improvement City Technology Limited reserves the right to make product changes without notice. No liability is accepted for any consequential losses, injury or damage resulting from the use of this document or from any omissions or errors herein. The data is given for guidance only. It does not constitute a specification or an offer for sale. The products are always subject to a programme of improvement and testing which may result in some changes in the characteristics quoted. As the products may be used by the client in circumstances beyond the knowledge and control of City Technology Limited, we cannot give any warranty as to the relevance of these particulars to an application. It is the clients' responsibility to carry out the necessary tests to determine the usefulness of the products and to ensure their safety of operation in a particular application.

Performance characteristics on this data sheet outline the performance of newly supplied sensors. Output signal can drift below the lower limit over time.

Doc. Ref: mmo1.indd Iss 3 ECN I 2385  
18<sup>th</sup> April 2011

Page 2 of 2

[www.citytech.com](http://www.citytech.com)

City Technology Limited

City Technology Centre, Walton Road, Portsmouth, Hampshire PO6 1SZ UK

Tel +44 23 9232 5511 Fax +44 23 9238 6611





**Product Data Sheet****MND-1S MediceL<sup>®</sup>**Nitrogen Dioxide (NO<sub>2</sub>) Gas Sensor  
Part Number: AG010-H00**Key Features & Benefits:**

- Capable of continuous measurement
- 4th electrode for additional temperature stability

**Technical Specifications****MEASUREMENT**

Operating Principle	4-electrode electrochemical
Measurement Range	0-50 ppm NO <sub>2</sub>
Maximum Overload	200 ppm
Output Signal	0.5 ± 0.1 µA/ppm
Response Time (T <sub>90</sub> )	< 50 seconds
Typical Baseline Offset (clean air)	-0.75 to +0.75 ppm equivalent
Repeatability	2% of signal
Linearity	Linear

**ELECTRICAL**

Recommended Load Resistor	10 Ω
Bias Voltage	Not Required
Recommended Gain	0.8

**MECHANICAL**

Weight	21 g (nominal)
Housing Material	20% glass-filled polypropylene
Colour Coded Ring	Black
Orientation	Any

**ENVIRONMENTAL**

Typical Applications	Inhaled Nitric Oxide Therapy
Operating Temperature Range	-20°C to +50°C
Recommended Storage Temp	0°C to +20°C
Operating Pressure Range	800 - 1200 mBar
Differential Pressure Range	±100 mBar
Storage Temperature Range	800 - 1200 mBar
Operating Humidity Range	15% to 90% RH non-condensing

**LIFETIME**

Typical Long Term Output Drift	2% signal loss/month
Expected Operating Life	1 year
Standard Warranty	12 months from date of despatch

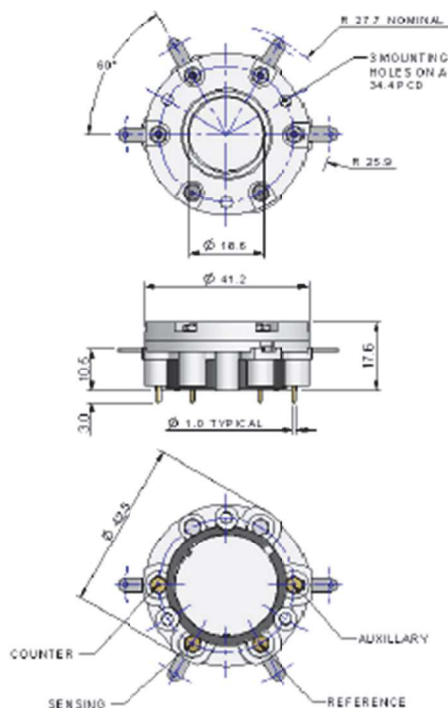
**Product Dimensions**

All dimensions in mm  
All tolerances ±0.15 mm  
unless otherwise stated

**IMPORTANT NOTE:**

Connection should be made via recommended mating parts only. Soldering to the sensor will damage it and invalidate the warranty.

All performance data is based on measurements made with cylinder gases using a flow rate of 100 ml/min. Conditions at 20°C, 50% RH and 1013 mBar, using City Technology recommended circuitry. For sensor performance data under other conditions, contact City Technology.

# Product Data Sheet

## Poisoning

CiTiceLs are designed for operation in a wide range of environments and harsh conditions, however it is important that exposure to high concentrations of solvent vapours is avoided, both during storage, fitting into instruments and operation.

When using sensors with printed circuit boards (PCBs), degreasing agents should be used before the sensor is fitted. Do not glue directly on or near the CiTiceL as the solvent may cause crazing of the plastic.

## Cross Sensitivity Table

Whilst CiTiceLs are designed to be highly specific to the gas they are intended to measure, they will still respond to some degree to various gases. The table below is not exclusive and other gases not included in the table may still cause a sensor to react.

<u>Gas</u>	<u>Response</u>
Carbon Monoxide (CO)	None
Nitrous Oxide (N <sub>2</sub> O)	None
Nitric Oxide (NO)	None
Desflurane	None
Isoflurane	None
Halothane	None

The cross-sensitivity values quoted are based on tests conducted on a small number of sensors. They are intended to indicate sensor response to gases other than the target gas. Sensors may behave differently with changes in ambient conditions and any batch may show significant variation from the values quoted.

N.B. Unaffected by operation in 100% oxygen

**WARNING:** By the nature of the technology used, any electrochemical or catalytic bead sensor can potentially fail to meet specification without warning. Although City Technology makes every effort to ensure the reliability of our products of this type, where life safety is a performance requirement of the product, and we recommend that all sensors and all instruments using these sensors are checked for response to gas before use.

Every effort has been made to ensure the accuracy of this document at the time of printing. In accordance with the company's policy of continued product improvement City Technology Limited reserves the right to make product changes without notice. No liability is accepted for any consequential losses, injury or damage resulting from the use of this document or from any omissions or errors herein. The data is given for guidance only. It does not constitute a specification or an offer for sale. The products are always subject to a programme of improvement and testing which may result in some changes in the characteristics quoted. As the products may be used by the client in circumstances beyond the knowledge and control of City Technology Limited, we cannot give any warranty as to the relevance of these particulars to an application. It is the clients' responsibility to carry out the necessary tests to determine the usefulness of the products and to ensure their safety of operation in a particular application. Performance characteristics on this data sheet outline the performance of newly supplied sensors. Output signal can drift below the lower limit over time.

Doc. Ref: mnd-1s.indd iss 2 ECN1 2266  
2<sup>nd</sup> December 2010

Page 2 of 2

[www.citytech.com](http://www.citytech.com)

City Technology Limited  
City Technology Centre, Walton Road, Portsmouth, Hampshire PO6 1SZ UK  
Tel +44 23 9232 5511 Fax +44 23 9238 6611



## 7.5. Oxygen Sensor Specifications

REV	DCO'S AFFECTING THIS DRAWING	DATE	APPROVED
A	INITIAL REL. #1209	4/5/99	D.L.
C	DCO # 3808	8/24/11	D.L.
C	REVISED STORAGE TEMPERATURE		

ALL PRODUCT SPECIFICATIONS ARE APPLICABLE AT STANDARD CONDITIONS: 1013 MILLIBAR, 25° C DRY AIR.

- Output:  
9.0 to 13.0 mV
- Operation:  
Temperature: 0° – 40° C  
Pressure: 600 – 1750 mBar  
Relative Humidity: up to 100% RH  
(Condensing atmosphere over several hours)
- Storage Temperature Range:  
–20° to 50 °C  
5° to 30°C Recommended
- Range of Measurement (Full Scale):  
0 to 100% oxygen
- Zero Offset:  
Less than or equal to 0.20 mV when exposed to 100% nitrogen for 5 minutes
- 90% Response Time:  
Less than or equal to 13 seconds
- Linearity:  
<3% error
- Stability:  
Less than 1% of full scale over an 8 hour period between 20% and 100% Oxygen.
- Repeatability:  
±1% volume oxygen @ 100% oxygen applied for 5 minutes
- Interference:  
Less than 0.5% oxygen response to 80% Nitrous oxide  
Less than 0.5% oxygen response to 7.5% Halothane  
Less than 0.5% oxygen response to 7.5% Isoflurane  
Less than 0.5% oxygen response to 7.5% Enflurane  
Less than 0.5% oxygen response to 9% Sevoflurane  
Less than 0.5% oxygen response to 20% Desflurane  
Less than 0.5% oxygen response to 10% Carbon Dioxide
- Nominal Life:  
> 1,000,000% oxygen hours under normal operating conditions
- Warm-up Time:  
Less than 30 minutes after replacement of sensor
- Electrical Interface:  
3 Pin, Female, Molex Connector

UNLESS OTHERWISE SPECIFIED DIMENSIONS ARE IN INCHES AND PER ANSI Y14.5-1982		maxtec® SALT LAKE CITY, UTAH 84109	
XX = ±.005	ANGLES ±1°30'	SPECIFICATIONS MAX-14 OXYGEN SENSOR	
.XXX = ±.002	3/25/99		
DA LIVERY 8/15/11	PREP LARSEN	SIZE B	FROM NO. NUMBER R116P81
MF9 E. MEADS	CHKR D. GOETZ	4/5/99	REV C
	ENG C. CINDRICH	8/10/11	SCALE NONE
			SHEET 1 OF 2

## 7.6. Mass Flow Sensor Specifications

### Mass Flow Meter

0 - 2.00 L/min, 0.5 V - 4.5 V (0.5 V offset at zero, 4 V Span)



### ELECTRICAL CONNECTION

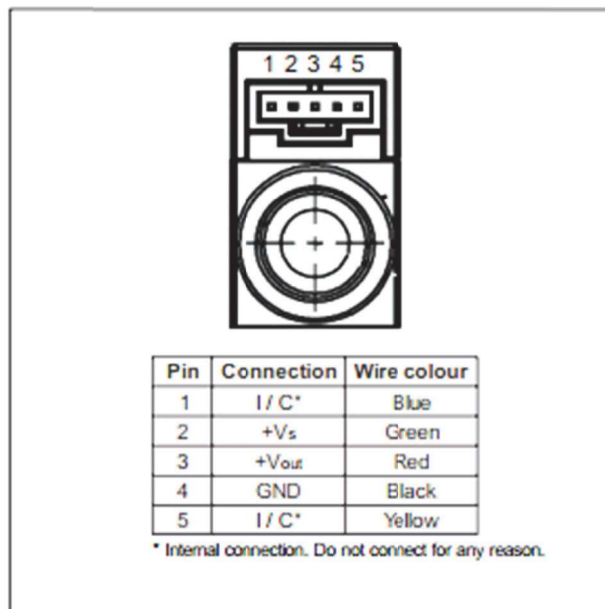

## 7.7. Recommended Practices for Handling of Gas Cylinders and Regulators to Maintain Gas Quality

Any time a regulator is installed on a tank or cylinder of compressed gas, certain precautions must be followed to prevent contamination of the gas in the tank with the air that is trapped in the dead space of the regulator. This dead space is composed of the volume of the nipple on the regulator that attaches to the valve on the tank, the volume of the valve on the tank exposed to air, that is not displaced by the nipple on the regulator when it is attached to the valve, and any volume in the high pressure side of the regulator.

Whenever a regulator is attached to a cylinder, it must be purged before use. The valve on the tank must not be opened and left open until the regulator is purged. The reason for this being, as soon as the valve is opened, the dead space described above becomes common with the tank. Any air or gas in this dead space will now diffuse into the tank, contaminating the contents.

The major concern with Nitric Oxide is that the oxygen in the air that is trapped in the dead space will unite with the Nitric Oxide to produce nitrogen dioxide. Each molecule of oxygen will convert two molecules of Nitric Oxide to nitrogen dioxide. Although the dead space volume is physically small, it carries sufficient oxygen to convert a significant amount of Nitric Oxide to nitrogen dioxide. This chemical reaction will have the effect of reducing the concentration of the Nitric Oxide and increasing the concentration of nitrogen dioxide. The levels of Nitric Oxide in the cylinders are quite low, typically less than 800 ppm and often 80 ppm for calibration gases.

On low concentrations in small tanks, just one regular installation without following proper purging technique can almost make the tank unusable.

Presented here are three methods of suggested practice to minimize contamination of cylinders. The first two are practiced by NIST, the first being the most desirable method. The third method is a next best solution that should give good results out in the field when a laboratory environment is not available.

### **Purge Method 1: (BEST)**

1. Install a shut-off valve on output of regulator.
2. Install and tighten the regulator onto tank.
3. Connect vacuum source to shut-off valve.
4. Open regulator so it will allow flow.
5. Open the shut-off valve and pull vacuum on regulator. If the gauge will indicate vacuum, draw down to 30 in/Hg.
6. Close shut-off valve.
7. Crack tank valve open and immediately close.
8. Open shut-off valve and pull down to 30 in/Hg again. Close shut-off valve.
9. Repeat steps 7 and 8 two more times.
10. Crack valve and immediately close.
11. Open shut-off valve and draw down to 0 in/Hg. Close shut-off valve.
12. Repeat steps 10 and 11 once more.
13. Tank valve may now be opened and left open.
14. Remove vacuum source.
15. The regulator is now purged and ready for use.

### **Purge Method 2:**

1. Install a shut-off valve on output of regulator.
2. Install and tighten the regulator onto tank.
3. Open regulator to allow flow through it.
4. Close shut-off valve.
5. Crack and immediately close the tank valve.
6. Open shut-off valve and bleed pressure to 0, preferably to an external vent. Close shut-off valve.
7. Repeat steps 5 and 6 four more times.
8. The tank valve may now be left open as needed.
9. The regulator is now purged and ready to use.

### **Purge Method 3:**

1. Install and tighten regulator onto tank.
2. Open regulator to allow flow through it.
3. Crack open and immediately close tank valve and allow regulator to bleed down to 0, venting the gas to atmosphere.
4. Repeat step 3 at least 5 more times to ensure that all air has been purged from regulator.
5. Connect to equipment and open the tank valve as needed.

Although not as elaborate as the previous two methods, this is far better than typical practice of attaching a regulator, opening the tank valve, and starting to use it. Once a regulator is installed on a tank, it should be left on the tank until the tank is empty to minimize the chance of tank contamination.

## **CONTAMINATION EFFECTS OF AIR ON NO<sub>2</sub> FORMATION IN NO/N<sub>2</sub>**

**Sample calculations to indicate the significance of contamination due to inadequate purging procedures:**

### LARGE 2040 LITER (SIZE 2R) TANKS:

2040 Liter cylinder, 800 ppm NO in N<sub>2</sub> @ 2000 psi

Contains 1632 ml of NO, balance N<sub>2</sub>.

1 molecule of O<sub>2</sub> will convert 2 molecules of NO to NO<sub>2</sub>.

Volume of air trapped between tank valve and regulator body is typically 1.25 ml or more.

Conceivably, an additional 0.75 ml could be contained in the regulator body for a total of 2 ml.

Internal dimensions of regulator nipple: 0.18" dia × 3.1" long = 0.079 in<sup>3</sup> = 1.29 ml

Internal dimensions of regulator nipple: 0.18" dia × 3.5" long = 0.089 in<sup>3</sup> = 1.46 ml

**Assuming 21% Oxygen in air, (.21 × 2 ml) = 0.42 ml of Oxygen will be available.**

**This can convert 0.84 ml of NO to NO<sub>2</sub>.**

0.84 ml represents  $[(0.84 / 1632) \times 100]\% = 0.05\%$  of the NO present in the tank.

0.05% of 800 ppm is 0.4 ppm.

Each time a regulator is mounted on a tank and not properly purged, the concentration of NO could be reduced by 0.4 ppm by diffusion of the Oxygen back into tank through the valve.

Conversely, NO<sub>2</sub> concentration could increase by 0.4 ppm each time.

As a tank empties, for example at 1000 psi, with 816 ml of NO left in the tank, 0.84 ml now represents  $[(0.84 / 816) \times 100]\% = 0.102\%$  of the NO present in the tank.

0.102% of 800 ppm is 0.82 ppm.

Each time a regulator is mounted on tank and not properly purged, the concentration of NO could be reduced by 0.82 ppm by diffusion of the Oxygen back into tank through the valve.

Conversely, NO<sub>2</sub> concentration could increase by 0.82 ppm each time.

As a tank empties, it becomes much more critical to observe correct procedures to prevent contamination of the gases. The effect of contamination is cumulative.

With 80 ppm calibration gases, as used in the lab, a full 2040 liter tank will contain approximately 16.32 ml of NO at 2000 psi.

Now 0.84 ml represents  $[(0.84 / 16.32) \times 100]\% = 5\%$  of the NO present in the tank.

5% of 80 ppm is now 4 ppm.....very significant!

As a tank empties, this becomes more significant.

#### SMALL 97 LITER (SIZE 6R) TANKS:

97 Liter cylinder, 800 ppm NO in N<sub>2</sub> @ 1600 psi

Contains 77.6 ml of NO, balance N<sub>2</sub>.

If the same regulator was used, 0.84 ml of NO now represents  $(84 / 77.6)\% = 1.08\%$  of the available NO.

1.08% of 800 ppm is 8.6 ppm.

The small silver transport regulators appear to have approximately 1 ml of dead space or about half that of the other regulators.

This still implies a 4.3 ppm change in NO and NO<sub>2</sub> concentrations.

NO by itself in nitrogen is stable. It does not decompose on its own.

7.8. System Wiring Diagram

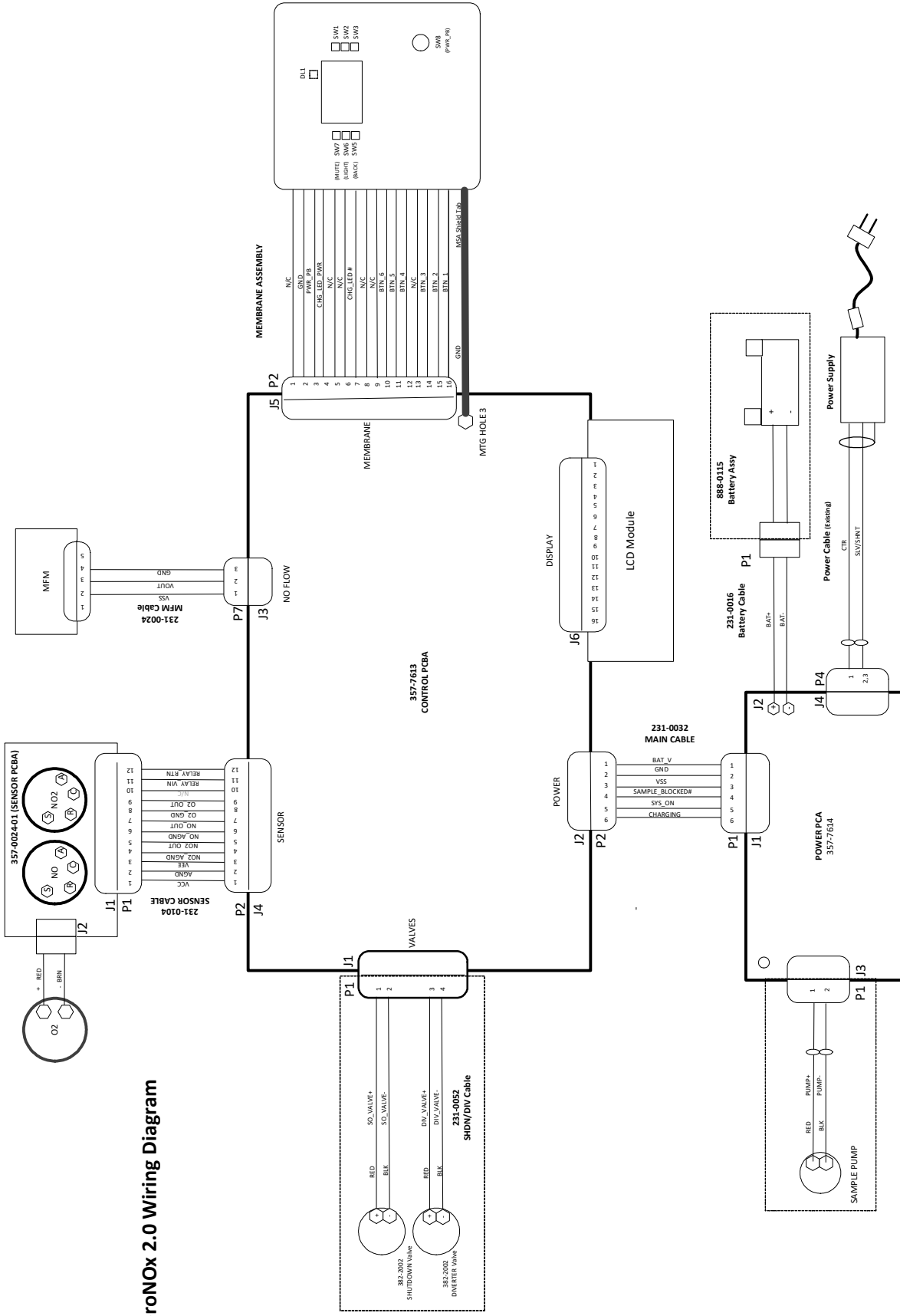

AeroNox 2.0 Wiring Diagram



7.9. Sensor Connection Block Diagram

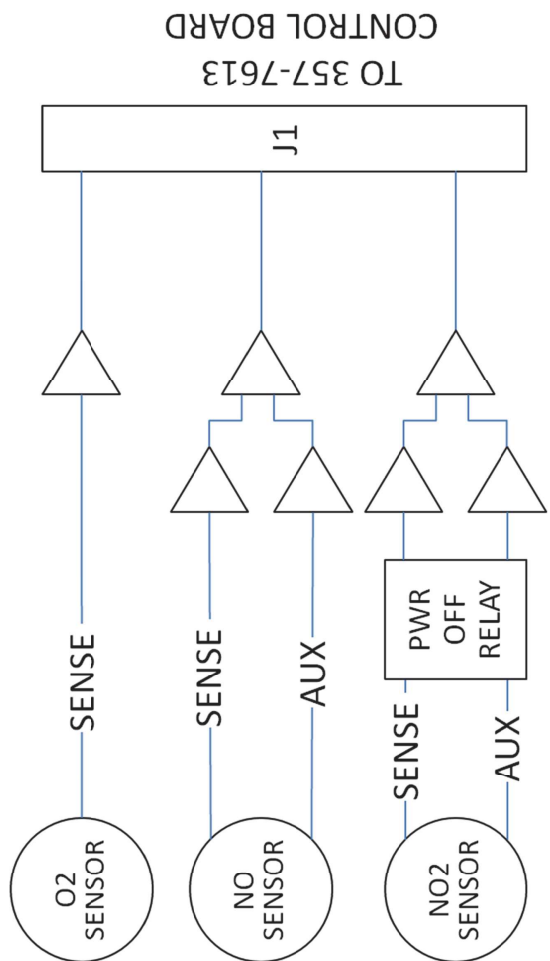

SENSOR BLOCK DIAGRAM